



website:<http://biz.LGservice.com>

LCD TV

SERVICE MANUAL

CHASSIS : LP78A

MODEL : 32LC41/4R	32LC41/4R-ZA
32LC42	32LC42-ZC
32LC43	32LC43-ZA/ZE
32LC44	32LC43-ZB

CAUTION

BEFORE SERVICING THE CHASSIS,
READ THE SAFETY PRECAUTIONS IN THIS MANUAL.

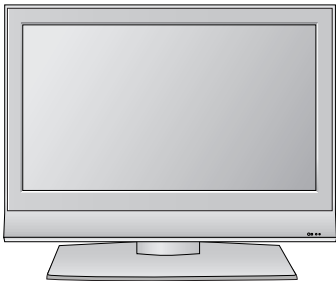

CONTENTS

CONTENTS	2
SAFETY PRECAUTIONS	3
SPECIFICATION	6
ADJUSTMENT INSTRUCTION	9
TROUBLE SHOOTING	17
BLOCK DIAGRAM.....	25
EXPLODED VIEW	26
EXPLODED VIEW PARTS LIST	27
REPLACEMENT PARTS LIST	28
SVC. SHEET	

SAFETY PRECAUTIONS

IMPORTANT SAFETY NOTICE

Many electrical and mechanical parts in this chassis have special safety-related characteristics. These parts are identified by \triangle in the Schematic Diagram and Replacement Parts List.

It is essential that these special safety parts should be replaced with the same components as recommended in this manual to prevent Shock, Fire, or other Hazards.

Do not modify the original design without permission of manufacturer.

General Guidance

An **isolation Transformer should always be used** during the servicing of a receiver whose chassis is not isolated from the AC power line. Use a transformer of adequate power rating as this protects the technician from accidents resulting in personal injury from electrical shocks.

It will also protect the receiver and its components from being damaged by accidental shorts of the circuitry that may be inadvertently introduced during the service operation.

If any fuse (or Fusible Resistor) in this TV receiver is blown, replace it with the specified.

When replacing a high wattage resistor (Oxide Metal Film Resistor, over 1W), keep the resistor 10mm away from PCB.

Keep wires away from high voltage or high temperature parts.

Before returning the receiver to the customer,

always perform an **AC leakage current check** on the exposed metallic parts of the cabinet, such as antennas, terminals, etc., to be sure the set is safe to operate without damage of electrical shock.

Leakage Current Cold Check(Antenna Cold Check)

With the instrument AC plug removed from AC source, connect an electrical jumper across the two AC plug prongs. Place the AC switch in the on position, connect one lead of ohm-meter to the AC plug prongs tied together and touch other ohm-meter lead in turn to each exposed metallic parts such as antenna terminals, phone jacks, etc.

If the exposed metallic part has a return path to the chassis, the measured resistance should be between $1M\Omega$ and $5.2M\Omega$.

When the exposed metal has no return path to the chassis the reading must be infinite.

An other abnormality exists that must be corrected before the receiver is returned to the customer.

Leakage Current Hot Check (See below Figure)

Plug the AC cord directly into the AC outlet.

Do not use a line Isolation Transformer during this check.

Connect 1.5K/10watt resistor in parallel with a 0.15uF capacitor between a known good earth ground (Water Pipe, Conduit, etc.) and the exposed metallic parts.

Measure the AC voltage across the resistor using AC voltmeter with 1000 ohms/volt or more sensitivity.

Reverse plug the AC cord into the AC outlet and repeat AC voltage measurements for each exposed metallic part. Any voltage measured must not exceed 0.75 volt RMS which is corresponds to 0.5mA.

In case any measurement is out of the limits specified, there is possibility of shock hazard and the set must be checked and repaired before it is returned to the customer.

Leakage Current Hot Check circuit

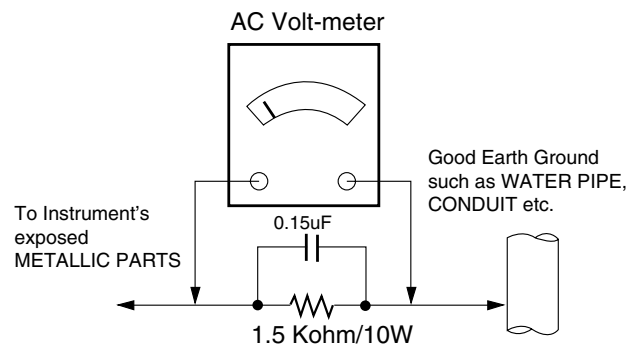

SERVICING PRECAUTIONS

CAUTION: Before servicing receivers covered by this service manual and its supplements and addenda, read and follow the *SAFETY PRECAUTIONS* on page 3 of this publication.

NOTE: If unforeseen circumstances create conflict between the following servicing precautions and any of the safety precautions on page 3 of this publication, always follow the safety precautions. Remember: Safety First.

General Servicing Precautions

1. Always unplug the receiver AC power cord from the AC power source before;
 - a. Removing or reinstalling any component, circuit board module or any other receiver assembly.
 - b. Disconnecting or reconnecting any receiver electrical plug or other electrical connection.
 - c. Connecting a test substitute in parallel with an electrolytic capacitor in the receiver.
CAUTION: A wrong part substitution or incorrect polarity installation of electrolytic capacitors may result in an explosion hazard.
2. Test high voltage only by measuring it with an appropriate high voltage meter or other voltage measuring device (DVM, FETVOM, etc) equipped with a suitable high voltage probe. Do not test high voltage by "drawing an arc".
3. Do not spray chemicals on or near this receiver or any of its assemblies.
4. Unless specified otherwise in this service manual, clean electrical contacts only by applying the following mixture to the contacts with a pipe cleaner, cotton-tipped stick or comparable non-abrasive applicator; 10% (by volume) Acetone and 90% (by volume) isopropyl alcohol (90%-99% strength)
CAUTION: This is a flammable mixture.
Unless specified otherwise in this service manual, lubrication of contacts is not required.
5. Do not defeat any plug/socket B+ voltage interlocks with which receivers covered by this service manual might be equipped.
6. Do not apply AC power to this instrument and/or any of its electrical assemblies unless all solid-state device heat sinks are correctly installed.
7. Always connect the test receiver ground lead to the receiver chassis ground before connecting the test receiver positive lead.
Always remove the test receiver ground lead last.
8. *Use with this receiver only the test fixtures specified in this service manual.*
CAUTION: Do not connect the test fixture ground strap to any heat sink in this receiver.

Electrostatically Sensitive (ES) Devices

Some semiconductor (solid-state) devices can be damaged easily by static electricity. Such components commonly are called *Electrostatically Sensitive (ES) Devices*. Examples of typical ES devices are integrated circuits and some field-effect transistors and semiconductor "chip" components. The following techniques should be used to help reduce the incidence of component damage caused by static by static electricity.

1. Immediately before handling any semiconductor component or semiconductor-equipped assembly, drain off any electrostatic charge on your body by touching a known earth ground. Alternatively, obtain and wear a commercially available discharging wrist strap device, which should be removed to prevent potential shock reasons prior to applying power to the

unit under test.

2. After removing an electrical assembly equipped with ES devices, place the assembly on a conductive surface such as aluminum foil, to prevent electrostatic charge buildup or exposure of the assembly.
3. Use only a grounded-tip soldering iron to solder or unsolder ES devices.
4. Use only an anti-static type solder removal device. Some solder removal devices not classified as "anti-static" can generate electrical charges sufficient to damage ES devices.
5. Do not use freon-propelled chemicals. These can generate electrical charges sufficient to damage ES devices.
6. Do not remove a replacement ES device from its protective package until immediately before you are ready to install it. (Most replacement ES devices are packaged with leads electrically shorted together by conductive foam, aluminum foil or comparable conductive material).
7. Immediately before removing the protective material from the leads of a replacement ES device, touch the protective material to the chassis or circuit assembly into which the device will be installed.
CAUTION: Be sure no power is applied to the chassis or circuit, and observe all other safety precautions.
8. Minimize bodily motions when handling unpackaged replacement ES devices. (Otherwise harmless motion such as the brushing together of your clothes fabric or the lifting of your foot from a carpeted floor can generate static electricity sufficient to damage an ES device.)

General Soldering Guidelines

1. Use a grounded-tip, low-wattage soldering iron and appropriate tip size and shape that will maintain tip temperature within the range or 500°F to 600°F.
2. Use an appropriate gauge of RMA resin-core solder composed of 60 parts tin/40 parts lead.
3. Keep the soldering iron tip clean and well tinned.
4. Thoroughly clean the surfaces to be soldered. Use a mall wire-bristle (0.5 inch, or 1.25cm) brush with a metal handle. Do not use freon-propelled spray-on cleaners.
5. Use the following unsoldering technique
 - a. Allow the soldering iron tip to reach normal temperature. (500°F to 600°F)
 - b. Heat the component lead until the solder melts.
 - c. Quickly draw the melted solder with an anti-static, suction-type solder removal device or with solder braid.
CAUTION: Work quickly to avoid overheating the circuit board printed foil.
6. Use the following soldering technique.
 - a. Allow the soldering iron tip to reach a normal temperature (500°F to 600°F)
 - b. First, hold the soldering iron tip and solder the strand against the component lead until the solder melts.
 - c. Quickly move the soldering iron tip to the junction of the component lead and the printed circuit foil, and hold it there only until the solder flows onto and around both the component lead and the foil.
CAUTION: Work quickly to avoid overheating the circuit board printed foil.
 - d. Closely inspect the solder area and remove any excess or splashed solder with a small wire-bristle brush.

IC Remove/Replacement

Some chassis circuit boards have slotted holes (oblong) through which the IC leads are inserted and then bent flat against the circuit foil. When holes are the slotted type, the following technique should be used to remove and replace the IC. When working with boards using the familiar round hole, use the standard technique as outlined in paragraphs 5 and 6 above.

Removal

1. Desolder and straighten each IC lead in one operation by gently prying up on the lead with the soldering iron tip as the solder melts.
2. Draw away the melted solder with an anti-static suction-type solder removal device (or with solder braid) before removing the IC.

Replacement

1. Carefully insert the replacement IC in the circuit board.
2. Carefully bend each IC lead against the circuit foil pad and solder it.
3. Clean the soldered areas with a small wire-bristle brush. (It is not necessary to reapply acrylic coating to the areas).

"Small-Signal" Discrete Transistor

Removal/Replacement

1. Remove the defective transistor by clipping its leads as close as possible to the component body.
2. Bend into a "U" shape the end of each of three leads remaining on the circuit board.
3. Bend into a "U" shape the replacement transistor leads.
4. Connect the replacement transistor leads to the corresponding leads extending from the circuit board and crimp the "U" with long nose pliers to insure metal to metal contact then solder each connection.

Power Output, Transistor Device

Removal/Replacement

1. Heat and remove all solder from around the transistor leads.
2. Remove the heat sink mounting screw (if so equipped).
3. Carefully remove the transistor from the heat sink of the circuit board.
4. Insert new transistor in the circuit board.
5. Solder each transistor lead, and clip off excess lead.
6. Replace heat sink.

Diode Removal/Replacement

1. Remove defective diode by clipping its leads as close as possible to diode body.
2. Bend the two remaining leads perpendicular y to the circuit board.
3. Observing diode polarity, wrap each lead of the new diode around the corresponding lead on the circuit board.
4. Securely crimp each connection and solder it.
5. Inspect (on the circuit board copper side) the solder joints of the two "original" leads. If they are not shiny, reheat them and if necessary, apply additional solder.

Fuse and Conventional Resistor

Removal/Replacement

1. Clip each fuse or resistor lead at top of the circuit board hollow stake.
2. Securely crimp the leads of replacement component around notch at stake top.
3. Solder the connections.

CAUTION: Maintain original spacing between the replaced component and adjacent components and the circuit board to prevent excessive component temperatures.

Circuit Board Foil Repair

Excessive heat applied to the copper foil of any printed circuit board will weaken the adhesive that bonds the foil to the circuit board causing the foil to separate from or "lift-off" the board. The following guidelines and procedures should be followed whenever this condition is encountered.

At IC Connections

To repair a defective copper pattern at IC connections use the following procedure to install a jumper wire on the copper pattern side of the circuit board. (Use this technique only on IC connections).

1. Carefully remove the damaged copper pattern with a sharp knife. (Remove only as much copper as absolutely necessary).
2. Carefully scratch away the solder resist and acrylic coating (if used) from the end of the remaining copper pattern.
3. Bend a small "U" in one end of a small gauge jumper wire and carefully crimp it around the IC pin. Solder the IC connection.
4. Route the jumper wire along the path of the out-away copper pattern and let it overlap the previously scraped end of the good copper pattern. Solder the overlapped area and clip off any excess jumper wire.

At Other Connections

Use the following technique to repair the defective copper pattern at connections other than IC Pins. This technique involves the installation of a jumper wire on the component side of the circuit board.

1. Remove the defective copper pattern with a sharp knife. Remove at least 1/4 inch of copper, to ensure that a hazardous condition will not exist if the jumper wire opens.
2. Trace along the copper pattern from both sides of the pattern break and locate the nearest component that is directly connected to the affected copper pattern.
3. Connect insulated 20-gauge jumper wire from the lead of the nearest component on one side of the pattern break to the lead of the nearest component on the other side. Carefully crimp and solder the connections.
CAUTION: Be sure the insulated jumper wire is dressed so the it does not touch components or sharp edges.

SPECIFICATION

NOTE : Specifications and others are subject to change without notice for improvement.

1. Application range

This specification is applied to LP78A chassis.

2. Requirement for Test

Testing for standard of each part must be followed in below condition.

- (1) Temperature : 25 ± 5°C(77 ± 9°F), CST : 40 ± 5°C
- (2) Humidity : 65% ± 10%
- (3) Power : Standard input voltage (100-240V~, 50/60Hz)
*Standard Voltage of each products is marked by models

(4) Specification and performance of each parts are followed each drawing and specification by part number in accordance with BOM.

(5) The receiver must be operated for about 20 minutes prior to the adjustment.

3. Test method

3.1 Performance : LGE TV test method followed

3.2 Demanded other specification

Safety : CE, IEC Specification

EMC : CE, IEC

4. General Specification(LCD Module)

Item	Specification		Measurement	Result	Remark				
Display Screen Device	26/27/32/37/42" wide Color Display Module				LCD				
Aspect Ratio	16:9								
LCD Module	26/27/32/37/42" TFT WXGA LCD				MAKER : AUO/CMO/LPL/CPT				
Operating Environment	Temp. : 0 ~ 40 deg, Humidity : 0 ~ 85%				LGE SPEC				
Storage Environment	Temp. : -20 ~ 60 deg, Humidity : 0 ~ 85 %								
Input Voltage	100-240V~, 50/60Hz								
Power Consumption	Power on (Green) ≤ TBD (42") ≤ max (26", 27", 32", 37")				Volume: 1/8 volume of sound distortion point				
	St-By (Red) : 1.0 W								
LCD Module	AUO	Outline Dimension	26"	626.0 x 373.0 x 47.5	mm	(H) x (V) x (D) [with inverter]			
			32"	760.0 x 450.0 x 45	mm				
			37"	877.0 x 514.6 x 54.7	mm				
		Pixel Pitch	26"	0.4215	mm				
			32"	0.51075					
			37"	0.6 x 0.6			(H) x (W)		
		Back Light	26",32"	8 U-lamp					
			37"	10 U-lamp					
		CMO	Outline Dimension	27"	637.55 x 379.8 x 40.7		mm	(H) x (V) x (D) [with inverter]	
				32"	760 x 450 x 47.53				
			Pixel Pitch	27"	0.1455 x 0.4365		mm		(H) x (V)
				32"	0.1730 x 0.5190				
	Back Light		27"	14 CCFL					
			32"	16 CCFL					
	LPL	Outline Dimension	26"	626 x 373 x 44.1	mm	(H) x (V) x (D) [with inverter] (H) x (V)			
			32"	760.0 x 450.0 x 48.0					
			37"	877.0 x 516.8 x 55.5					
			42"	1006 x 610 x 56					
		Pixel Pitch	26"	0.1405 x 0.4215	mm				
			32"	0.17025 x 0.51075					
			37"	0.200 x 0.600					
			42"	0.227 x 0.681					
		Back Light	26"	18 EEFL (17 EEFL)			(LC260WX2-SLB3)		
			32"	18 EEFL					
37"			20 EEFL						
42"			20 CCFL						
Display Colors		16.7M (16,777,216)			(LPL 26")				
Coating		3H, AG							

5. Model Specification(EU)

Item	Specification	Remark	
Market	EU		
Broadcasting system	PAL BG/DK, PAL I/II, SECAM L/L'		
Available Channel	BAND	PAL	
	VHF/UHF	C1_C69	
	CATV	S1_S47	
Receiving system	Upper Heterodyne		
SCART Input(2EA)	PAL, SECAM, NTSC	Full Scart 1EA, Harf 1EA	
Video Input (1EA)	PAL, SECAM, NTSC	Side AV	
S-Video Input (1EA)	PAL, SECAM, NTSC	Side AV	S-Video Priority
Component Input (1EA)	Y/Cb/Cr, Y/ Pb/Pr		
RGB Input (1EA)	RGB-PC		
HDMI Input (2EA)	HDMI-DTV		
Audio Input (4EA)	PC Audio, AV (3A), Component (1EA)	L/R Input(PC 1EA, SCART 2EA, SIDE AV 1EA, Component 1EA)	
Variable Audio out(1EA)			

6. Component Video Input (Y, P_B, P_R)

Resolution	H-freq(kHz)	V-freq(kHz)	Pixel clock(MHz)	Proposed
720*480	15.73	59.94	13.500	SDTV, DVD 480I(525I)
720*480	15.75	60.00	13.514	SDTV, DVD 480I(525I)
720*576	15.625	50.00	13.500	SDTV, DVD 576I(625I) 50Hz
720*480	31.47	59.94	27.000	SDTV 480P
720*480	31.50	60.00	27.027	SDTV 480P
720*576	31.25	50.00	27.000	SDTV 576P 50Hz
1280*720	44.96	59.94	74.176	HDTV 720P
1280*720	45.00	60.00	74.250	HDTV 720P
1280*720	37.50	50.00	74.25	HDTV 720P 50Hz
1920*1080	33.72	59.94	74.176	HDTV 1080I
1920*1080	33.75	60.00	74.250	HDTV 1080I
1920*1080	28.125	50.00	74.250	HDTV 1080I 50Hz

7. RGB Input (Analog PC)

Resolution	H-freq(kHz)	V-freq(kHz)	Pixel clock(MHz)	Proposed	Remark
640*350	31.468	70.80	25.17	EGA	
720*400	31.469	70.80	28.321	DOS	
640*480	31.469	59.94	25.17	VESA(VGA)	
800*600	37.879	60.31	40.00	VESA(SVGA)	
1024*768	48.363	60.00	65.00	VESA(XGA)	
1280*768	47.776	59.87	79.50	WXGA	XGA only
1360*768	47.720	59.799	84.75	WXGA	XGA only
1366*768	47.720	59.799	84.75	WXGA	XGA only

8. HDMI input (DTV)

Resolution	H-freq(kHz)	V-freq(kHz)	Pixel clock(MHz)	Proposed
720*480	15.75	60.00	13.514	SDTV, DVD 480I(525I)
720*480	15.73	59.94	13.500	SDTV, DVD 480I(525I)
720*576	15.625	50.00	13.500	SDTV, DVD 576I(625I) 50Hz
720*480	31.47	59.94	27.000	SDTV 480P
720*480	31.50	60.00	27.027	SDTV 480P
720*576	31.25	50.00	27.000	SDTV 576P 50Hz
1280*720	44.96	59.94	74.176	HDTV 720P
1280*720	45.00	60.00	74.250	HDTV 720P
1280*720	37.50	50.00	74.25	HDTV 720P 50Hz
1920*1080	33.72	59.94	74.176	HDTV 1080I
1920*1080	33.75	60.00	74.250	HDTV 1080I
1920*1080	28.125	50.00	74.250	HDTV 1080I 50Hz
1920*1080	67.432	59.94	148.350	HDTV 1080P
1920*1080	67.5	60	148.5	HDTV 1080P
1920*1080	56.250	50	148.5	HDTV 1080P 50Hz

ADJUSTMENT INSTRUCTION

1. Application Range

This spec sheet is applied all of the 26/32/37/42" LCD TV(LP78A) by manufacturing LG TV Plant all over the world.

2. Specification

- 1) Because this is not a hot chassis, it is not necessary to use an isolation transformer. However, the use of isolation transformer will help protect test instrument.
- 2) Adjustment must be done in the correct order.
- 3) The adjustment must be performed in the circumstance of $25\pm 5^{\circ}\text{C}$ of temperature and $65\pm 10\%$ of relative humidity if there is no specific designation.
- 4) The input voltage of the receiver must keep 100~220V, 50/60Hz.
- 5) Before adjustment, execute Heat-Run for 30 minutes at RF no signal.

3. Adjustment items

3.1. PCB assembly adjustment items

- 1) Download the VCTP main software (IC500,VCT_Pro)
- 2) Channel memory (IC501,EEPROM)
- 3) Color carrier Adjustment

3.2. SET assembly adjustment items

- 1) DDC Data input.
- 2) Adjustment of White Balance.
- 3) Factoring Option Data input.

4. PCB assembly adjustment method (Using VCTP Download program)

4.1. Download program installation

(1) Extract a Zip file



(2) Visual I2C & LPT Driver Installation

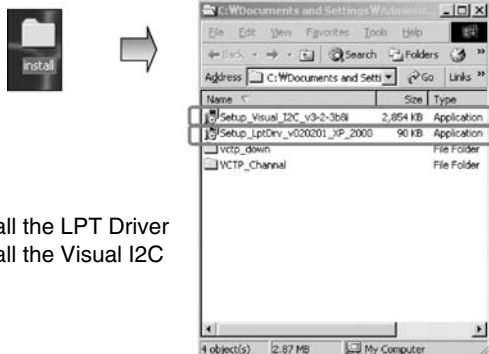

Install the LPT Driver
Install the Visual I2C

LPT Port Driver (LptDrv) Setups : Program Files > Micronas > Visual I2C > Port_Driver

*Use for Windows 95/98 : Setup_LptDrv_v0104_9x.exe

*Use for Windows 2000/XP : Setup_LptDrv_v0202_XP_2000.exe

*Use for Windows NT : Setup_LptDrv_v0104_NT.exe

(3) Verification (Start > Programs > Micronas > Visual I2C or LptDrv)

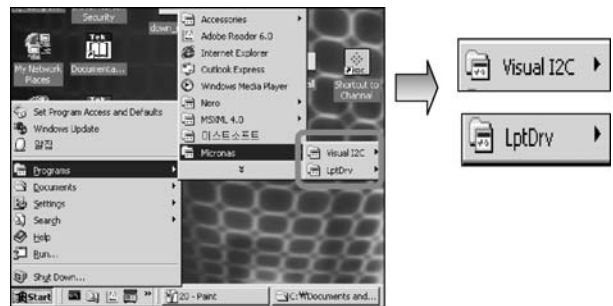

(4) LPT delay setting (File > Preference > LPT preferences)

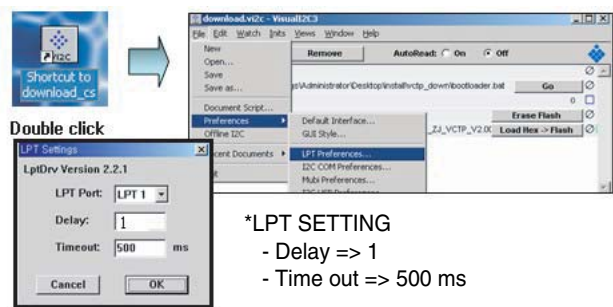

*LPT SETTING
- Delay => 1
- Time out => 500 ms

(5) Exchange the bootloader.bat file.

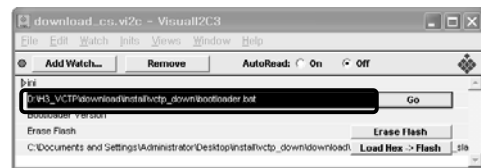

▶ Double click the Red

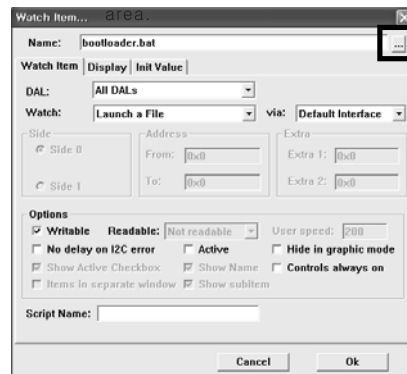

▶ Double click the Red area.

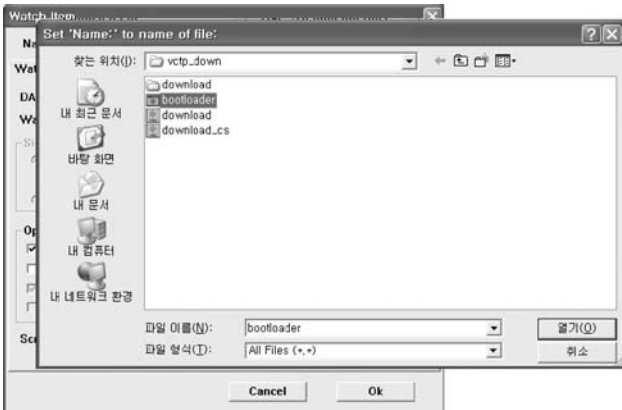

- => Select the "Bootloader.bat" file(install > VCTP_download > Bootloader)
- => Push "OK"

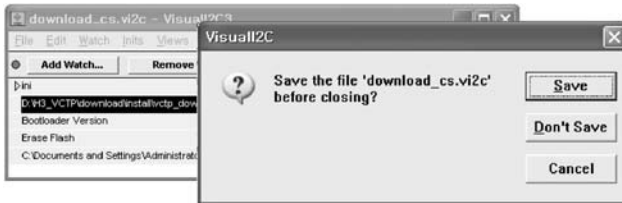

- => Finish the program, after saving the file "download_cs.vi2c" (if you click [X], the message appears automatically)

4.2. S/W program download

(1) Download method 1 (PCB Ass'y)



- 1) Connect the download jig to D-sub jack
- 2) Execute 'Download.vi2c' program in PC, then a main window will be opened



Double click



- 3) Double click the blue box and confirm "Bootloader Version" as 42.

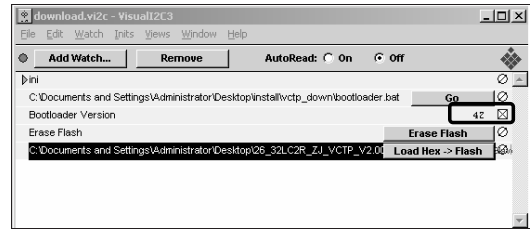

- 4) Click the "Erase Flash" button



- 5) Double click the download file low, then "edit" window will be opened

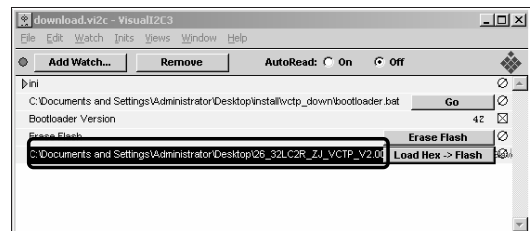

- 6) Click the choice button in the "edit window", then "file choice window" will be opened.

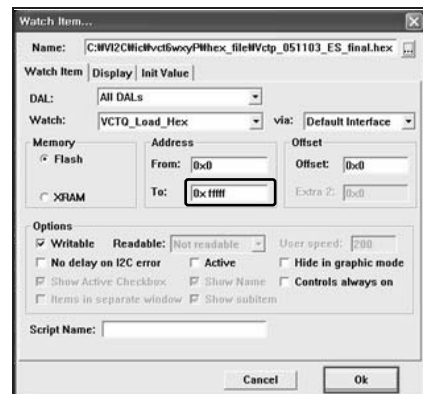

- 7) Choose the Hex file in folder and execute downloading with click " open" button.

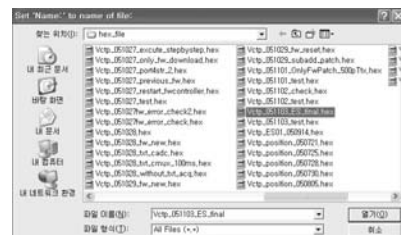

- 8) Click OK button at the "edit window".
- 9) Under Downloading process



- 10) If download is failed, for example "No acknowledge from slave". Execute download again from(1).

(2) Download method 2 (AV Plate Ass'y)

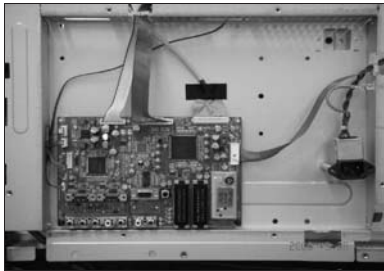

- 1) Push S/W 'ON' (connect SCL to GND using switch at Jig) and connect the download jig to D-sub jack.

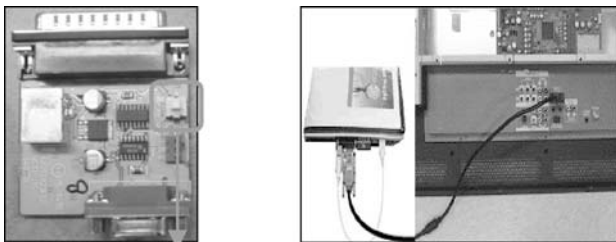

Push S/W

- 2) Supply the power (Stand-by 5V) and wait for 3 seconds.

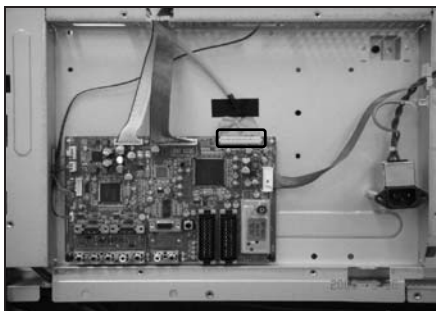

- 3) Push the S/W off (Disconnect SCL to GND using switch at jig).

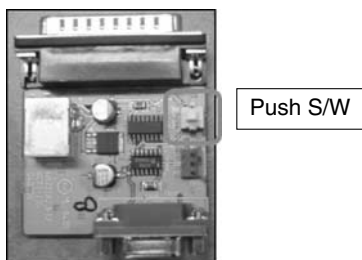

- 4) Execute 'Download.vi2c' program in PC, then a main widow will be opened.



Double click

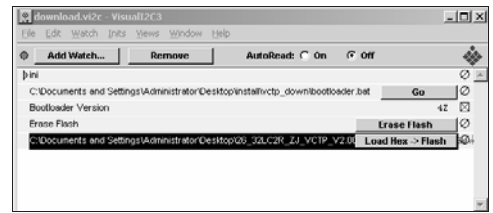

- 5) Double click the blue box and confirm "Bootloader Version" as 42.

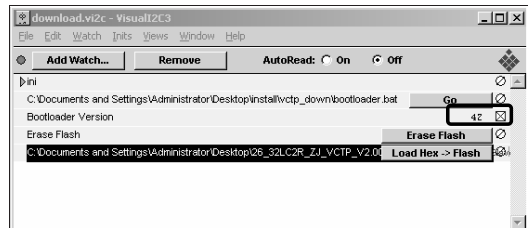

- 6) Click the "Erase Flash" button.

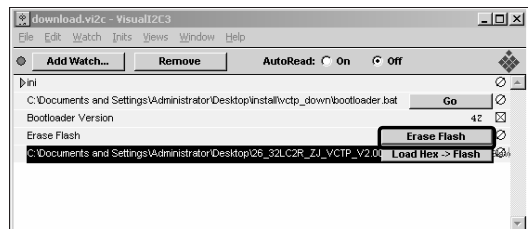

- 7) Double click the download file low then, "edit" window will be opened.

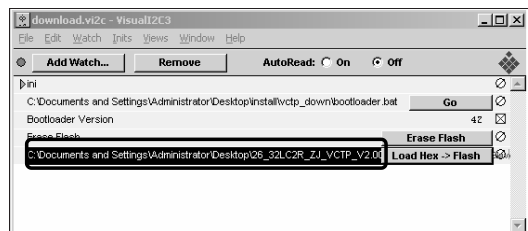

- 8) Chck the choice button I n the "edit window", then "file choice window' will be opened.

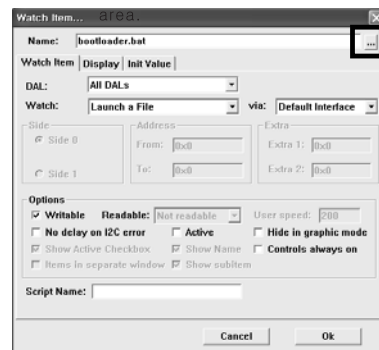

9) Choose the Hex file in folder and execute downloading with click "open button".

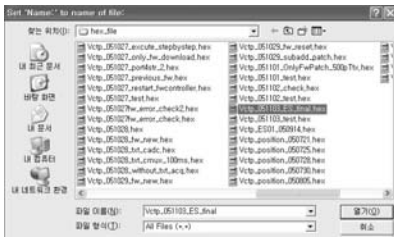

10) Click OK button at the "edit window"

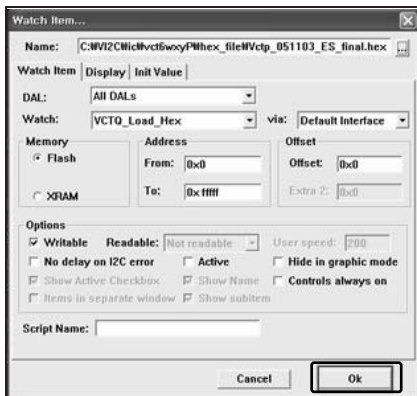

11) Under Downloading progress.

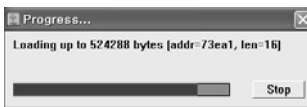

12) If download is failed, for example "No acknowledge from slave", execute download again from (1).

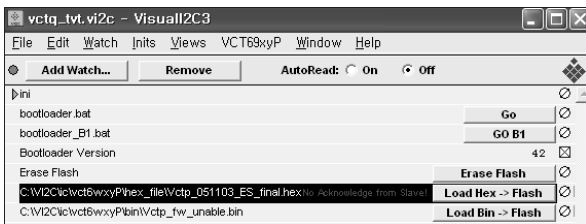

(3) Download method 3 (SET)

1) Push the "Tilt" button in an Adjust Remote control Then the LCD TV will change a "slave mode".

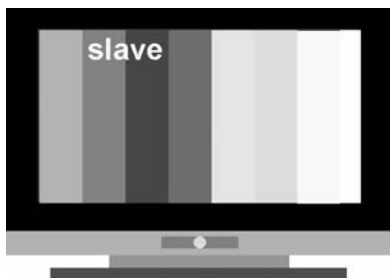

2) Connect Zig to TV using a D-sub cable.

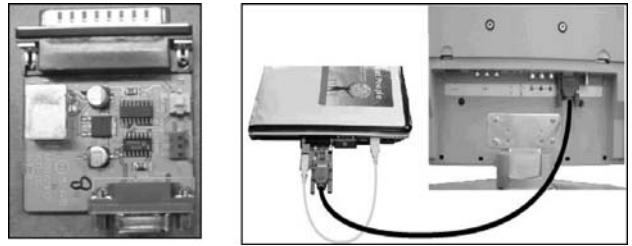

3) Execute 'Download_CS.vi2c' program in PC, then a main window will be opened.

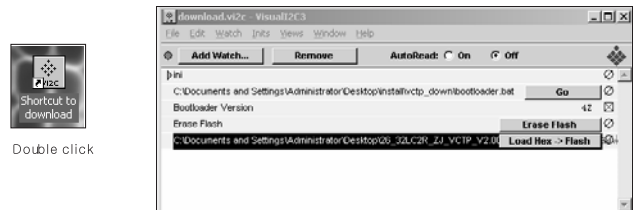

4) Click "GO" button.

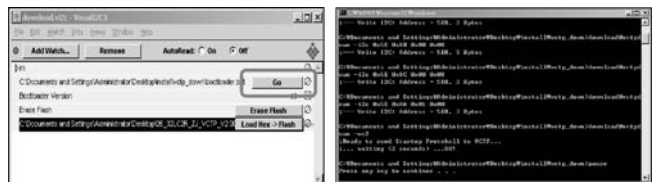

If you don't push the "go", the Hex file would not be downloaded although the download proceeds normally at first glance.

5) Double click the blue box and confirm "Bootloader Version" as 42.



6) Click the "Erase Flash" button

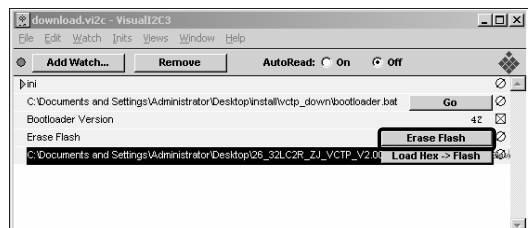

7) Double click the download file low then, "edit" window will be opened.



12) If download is failed, for example "No acknowledge from slave", execute download again from (1).

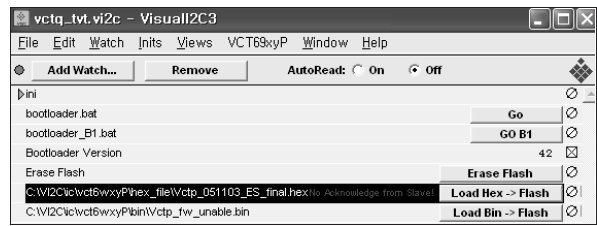

8) Click the choice button I n the "edit window", then "file choice window' will be opened

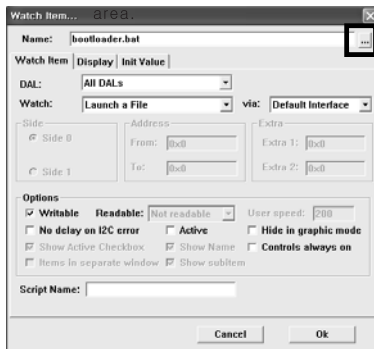

4.3. Channel memory download

- (1) Connect the download jig to D-sub jack.
- (2) Execute 'Channel.vi2c' program in PC, then a main window will be opened.



9) Choose the Hex file in folder and execute downloading with click "open button"

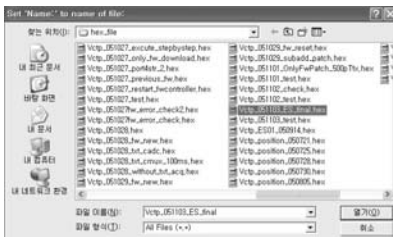

(3) Push the button change and select the Channel memory data.

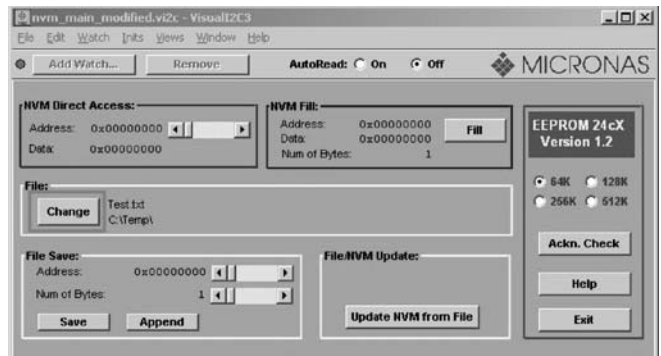

10) Click OK button at the "edit window"

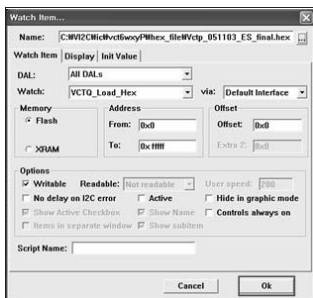

(4) Check the communication is OK or not.
=> Push the Read area (Ackn. Check) and check Cyan area is OK message.

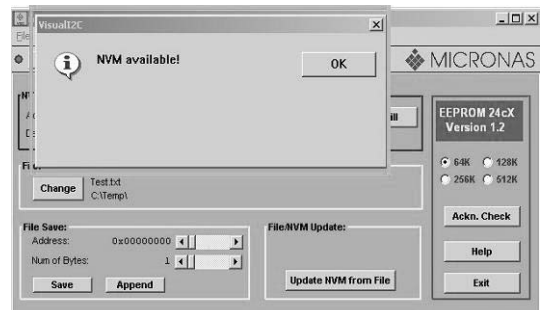

11) Downloading



(5) Push the Update NVM from File

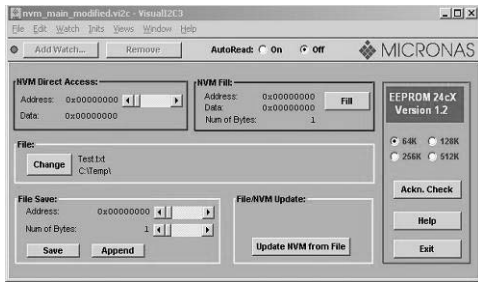

4.4. Tool Option Area Option Change

Before PCB check, have to change the Tool option and Area option

Option values are below

(If on changed the option, the input menu can differ the model spec.)

The input methods are same as other chassises(Use adj Key on the Adjust Remote control)

Tool Option		
Inch	ZA	TA
26	02240	04288
32	02256	04304
37	02264	04312
42	02272	04320
Area Option	Depend on PR	

4.5. Color carrier Adjustment (Inspection process)

(1) Tuning the RF signal

ZA, TA : PAL Philips Pattern(with color Bar)

MA : NTSC Digital Pattern(with color Bar)

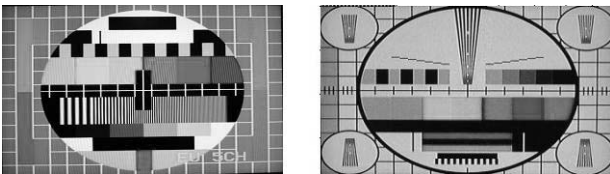

(2) push the "adj" key in the adjustment remote control.

5. EDID(The Extended Display Identification Data) /DDC(Display Data Channel) download

* Caution

- Use the proper signal cable for EDID Download.
- Never connect HDMI & D-SUB Cable at the same time.
- Use the proper cables below for EDID Writing.

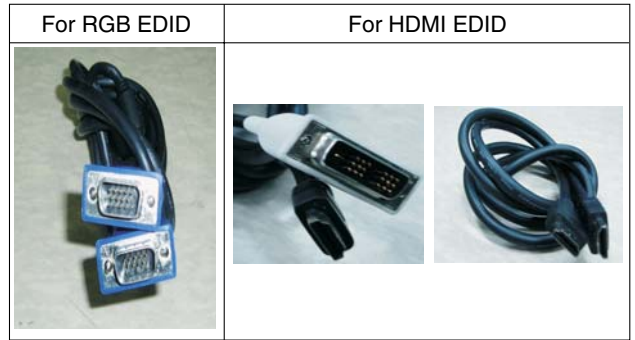

* EDID Data

Item	Condition	Data
Manufacturer ID	GSM	1E6D
Version	Digital : 1	01
Revision	Digital :3	03

<EDID DATA Analog Set : 128bytes>

Addr	00	01	02	03	04	05	06	07	08	09	0A	0B	0C	0D	0E	0F
0000	00	FF	FF	FF	FF	FF	FF	00	1E	6D	(a)			(b)		
0010		(c)	01	03	08	46	27	78	0A	D9	B0	A3	57	49	9C	25
0020	11	49	4B	A1	08	00	31	40	01	01	01	01	45	40	01	01
0030	61	40	01	01	01	01	1B	21	50	A0	51	00	1E	30	48	88
0040	35	00	BC	88	21	00	00	1C	4E	1F	00	80	51	00	1E	30
0050	40	80	37	0	BC	88	21	00	00	18	00	00	00	FD	00	3A
0060	3F	1F	32	09	00	0A	20	20	20	20				(d)		
0070																(e)

< EDID DATA HDMI Set : 256bytes>

Addr	00	01	02	03	04	05	06	07	08	09	0A	0B	0C	0D	0E	0F
0000	00	FF	FF	FF	FF	FF	FF	00	1E	6D	(a)			(b)		
0010		(c)	01	3	80	5C	34	96	0A	F3	30	A7	54	42	AA	26
0020	0F	48	4C	00	00	00	01	01	01	01	01	01	01	01	01	01
0030	01	01	01	01	01	01	8C	0A	D0	8A	20	E0	2D	10	10	3E
0040	96	00	C4	8E	21	00	00	18					(d)			
0050						(e)					00	00	00	FD	00	2D
0060	41	19	32	8	00	0A	20	20	20	20	20	20	00	00	00	00
0070	00	00	00	00	00	00	00	00	00	00	00	00	00	00	01	(f)
0080	02	03	1E	72	23	09	07	02	4B	10	1F	07	16	81	03	05
0090	14	13	12	04	83	01	00	00	65	03	0C	00	10	00	01	1D
00A0	80	18	71	1C	16	20	58	2C	25	00	C4	8E	21	00	00	9E
00B0	01	1D	80	D0	72	1C	16	20	10	2C	25	80	C4	8E	21	00
00C0	00	9E	01	1D	00	BC	52	D0	1E	20	B8	28	55	40	C4	8E
00D0	21	00	00	1E	8C	0A	D0	90	20	40	31	20	0C	40	55	00
00E0	C4	8E	21	00	00	18	01	1D	00	72	51	D0	1E	20	6E	28
00F0	55	00	C4	8E	21	00	00	1E	00	00	00	00	00	00	00	(g)

=> Detail EDID Options are below(a, b, c, d, e)

a. Product ID

Model Name	Product ID		
	DEC	HEX	EDID table
32LC4R	30113(A)	75A1	A175
	30114(D)	75A2	A275
32LC7R	30115 (A)	75A3	A375
	30116 (D)	75A4	A475
42LC4R	40075 (A)	9C8B	8B9C
	40076 (D)	9C8C	8C9C
42LC7R	40077(A)	9C8D	8D9C
	40078(D)	9C8E	8E9C

- b. Serial No : Controlled on production line
- c. Month, Year : Controlled on production line
ex) Monthly: '03' => '03'
Year: '2005' => '0F'
- d. Model Name(Hex):

Model Name	Model Name(HEX)																
32LC4R-ZA	00	00	00	FC	00	33	32	4C	43	34	52	2D	5A	41	0A	20	20
42LC4R-ZA	00	00	00	FC	00	34	32	4C	43	34	52	2D	5A	41	0A	20	20

e. Checksum (7EH) : Changeable by total EDID data

5.1. Sequence of Adjustment

- (1) DDC data of Analog-RGB
- 1) Init the data



- 2) Load the EDID data. (Open file)
[Analog - RGB : LP78A_RGB.ANA]
[Digital - HDMI : LP78A_HDMI.DVI]

3) Set the S/W as below



- 4) Push the "Write Data & Verify" button. And confirm "Yes".
- 5) If the writing is finished, you will see the "OK" message.

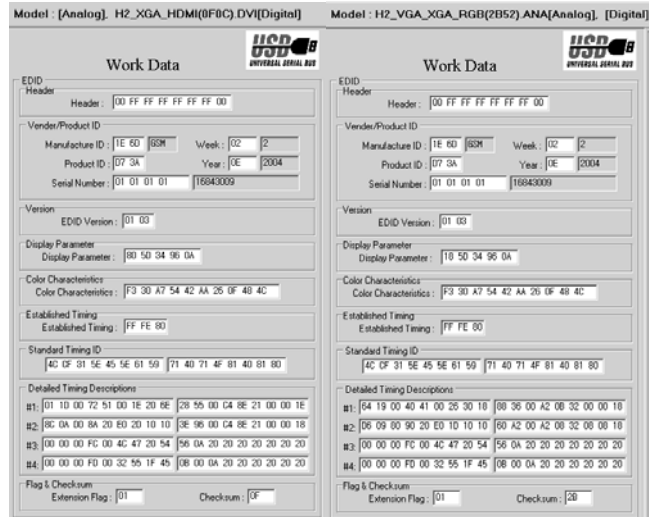

<EDID DATA>

6. Adjustment of White Balance

6.1. Required Equipment

- (1) Remote control for adjustment
- (2) Color Analyzer (CA-110 or CA-210 or same product)
- (3) Auto W/B adjustment instrument(only for Auto adjustment)

6.2. Connecting diagram of equipment for measuring (For Automatic Adjustment)

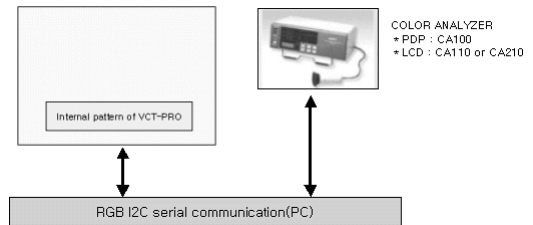

- (1) Enter the DDC adjust mode
 - Enter the DDC adjust mode at the same time heat-run mode when pushing the power on by power only key
 - Enter the adjust mode and change the input mode to AV (ZA : AV3, TA,MA : AV2)when pushing the Front av key
 - Maintain the DDC adjust mode with same condition of Heat-run -> Maintain after AC off/on in status of Heat-run pattern display
- (2) Release the DDC adjust mode
 - Release the adjust mode after AC off/on or std-by off/on in status of finishing the Hear-run mode
 - Release the Adjust mode when receiving the aging off command(F3 00 00) from adjustment equipment
 - Need to transmit the aging off command to TV set after finishing the adjustment.)

(3) DDC adjustment support command set

Adjustment	CMD(HEX)	ADR	
Aging On/Off	F3	00	FF : ON / OO : OFF
Input select	F4	00	0x10 : TV
			0x20 : AV1(SCART1)
			0x21 : AV2(SCART2)
			0x23 : AV3(Side AV)
			0x40 : Component1
			0x50 : RGB DTV
			0x60 : RGB PC
			0x90 : HDMI1 DTV
R GAIN	16	00	GAIN adjustment
G GAIN	18	00	
B GAIN	1A	00	

6.3. Adjustment of White Balance

(For Manual adjustment)

- Operate the zero-calibration of the CA-110 or CA-210, then stick sensor to LCD module when you adjust.
- For manual adjustment, it is also possible by the following sequence

1) Select RF no signal by pressing "POWER ON" key on remote control for adjustment then operate heat run more than 15 minutes.

(If not executed this step, the condition for W/B will be differ. The W/B condition is Picture Mode : Standard (MA : Optimum), Color Temp : Normal.)

2) Changing to the av mode by pushing the input or front av key.

3) Display the internal pattern of the VCT-Pro IC by pushing the IN-START.

4) Stick sensor to center of the screen and select each items (Red/Green/Blue Gain and Offset) using ▲/▼ (CH+/-) key on R/C.

5) Adjust R Gain / B Gain using ◀/▶ (VOL+/-) key on R/C.

6) Adjust it until color coordination becomes as below.

(Initially, R/G/B gain and R/G/B offset values are fixed as below)

Red Gain : 80 , Green Gain : 80 , Blue Gain : 80

Red Offset : 80 , Green Offset : 80 , Blue Offset : 80

* Target Value [Picture Mode : Standard (ZA, TA), Optimum(MA), Color Temp: Normal]

-Normal (9300K) x ; 0.283±0.003 y ; 0.298±0.003

-Luminance(Y) AV : upper 150 cd/m² (Typ : 350 cd/m²≥)

=> Reference Value(Automatically fixed)

- Cool(11000K): x:0.274±0.003, y: 0.286±0.003

- Warm(7200K) : x:0.303±0.003, y: 0.319±0.003

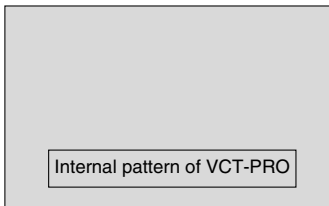

<Pattern for Adjustment of White Balance>

7) When adjustment is completed, Exit adjustment mode using EXIT key on R/C

6.4. Input the Shipping Option Data

- 1) Push the ADJ key in a Adjust Remote control.
- 2) Input the Option Number that was specified in the BOM, into the Shipping area.
- 3) The work is finished, Push ■ Key.

7. Default Value in Adjustment mode (Default values maybe modified the module condition)

7.1. White Balance

White Bdance		
RED	Gain	80
Green	Gain	80
Blue	Gain	80
Red	Offset	80
Green	Offset	80
Blue	Offset	80

<Default Value on OSD>

8. Internal press test

Item	Value	Unit	Remark
Dielectric Voltage (AC <-> FG)	1.5	kV	At 100mA for 1sec (Line)
			At 100mA for 1min (OQC)
Dielectric Voltage (Without FG)	3	kV	At 100mA for 1sec (Line)
			At 100mA for 1min (OQC)

9. Sound spec.

Item	Min	Typ	Max	Unit	Remark
Audio Practical Max Output, L(Mono)/R	6	7	9	W	LCD

TROUBLESHOOTING

1. No power

(1) Symptom

- 1) Minute discharge does not occur at module.
- 2) Front LED does not activate.

(2) Press check

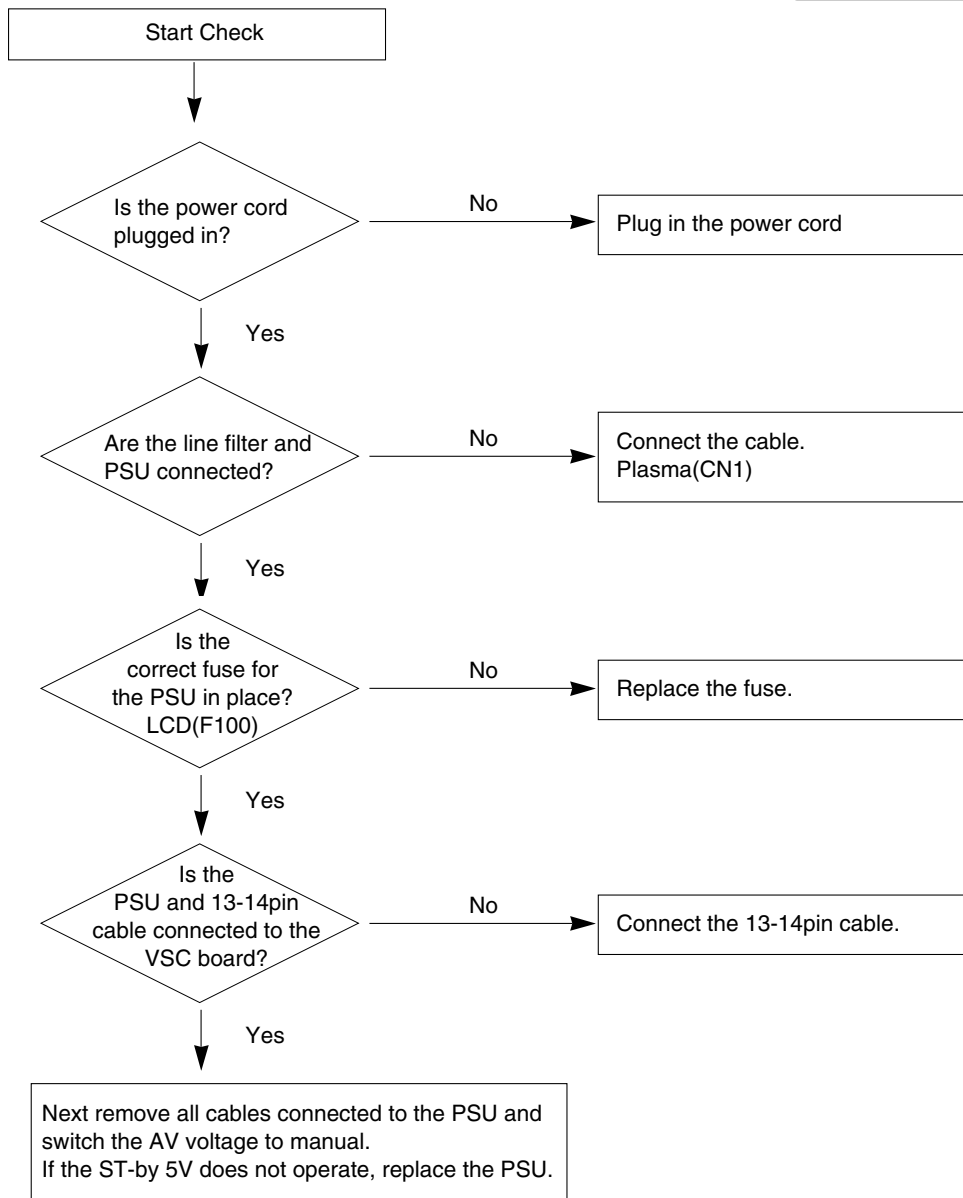
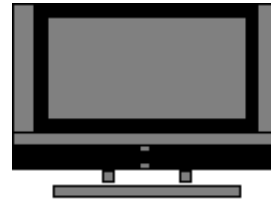

2. Protect mode

(1) Symptom

- 1) After lighting once it does not discharge minutely from the module.
- 2) The relay falls.(there is an audible "Click".)
- 3) The color of the front LED turns from green to red.

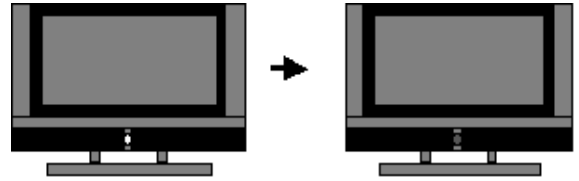

(2) Follow check

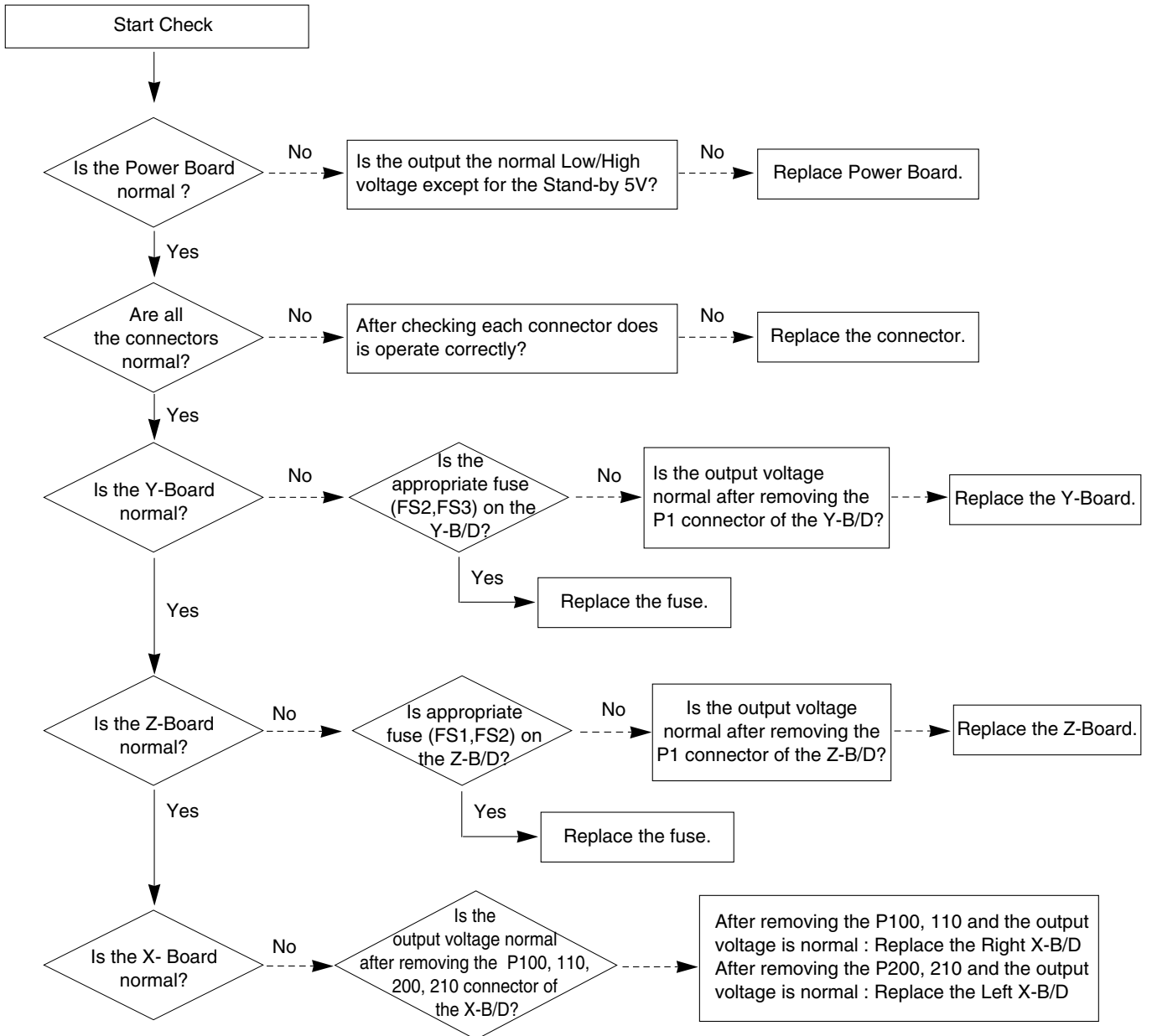

3. No Raster



(1) Symptom

- 1) No OSD or image are displayed on the screen.
- 2) The front LED remains green.

(2) Follow check

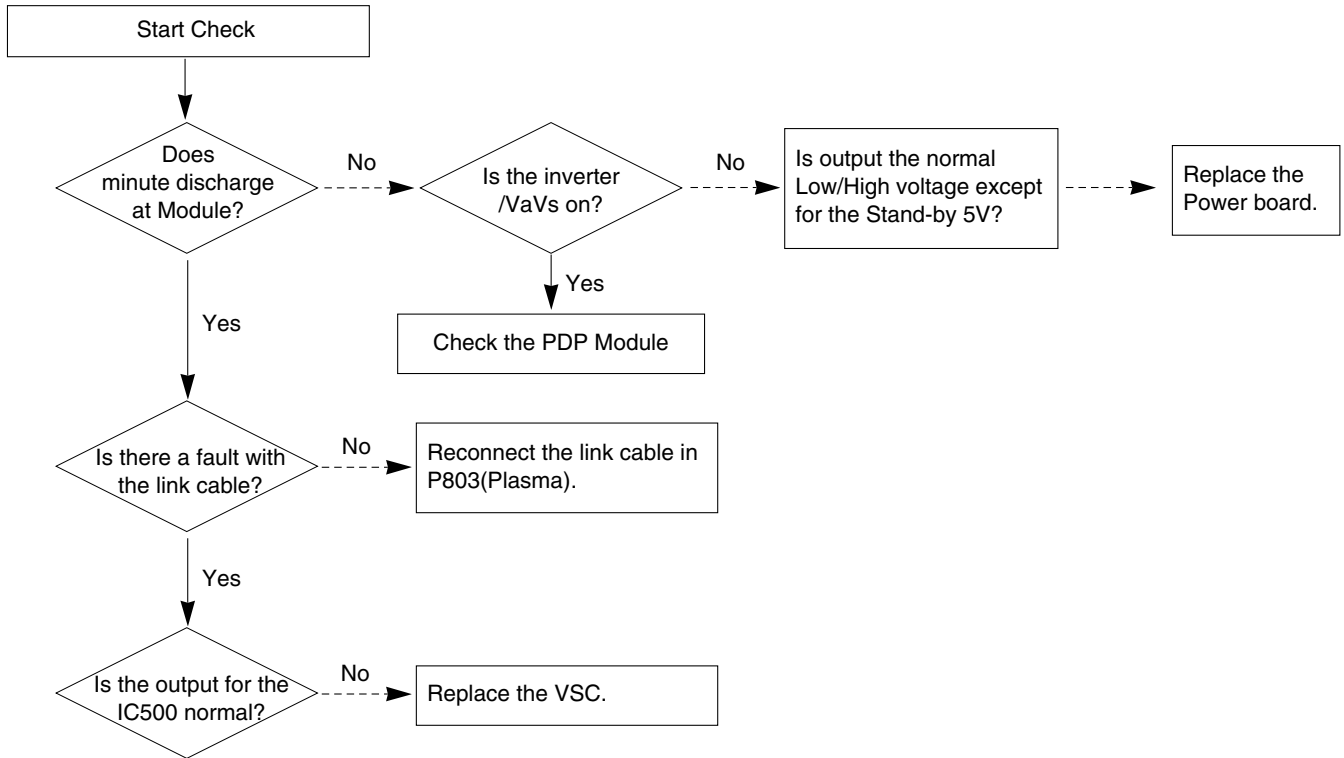

4. In the case an unusual display in RF mode.

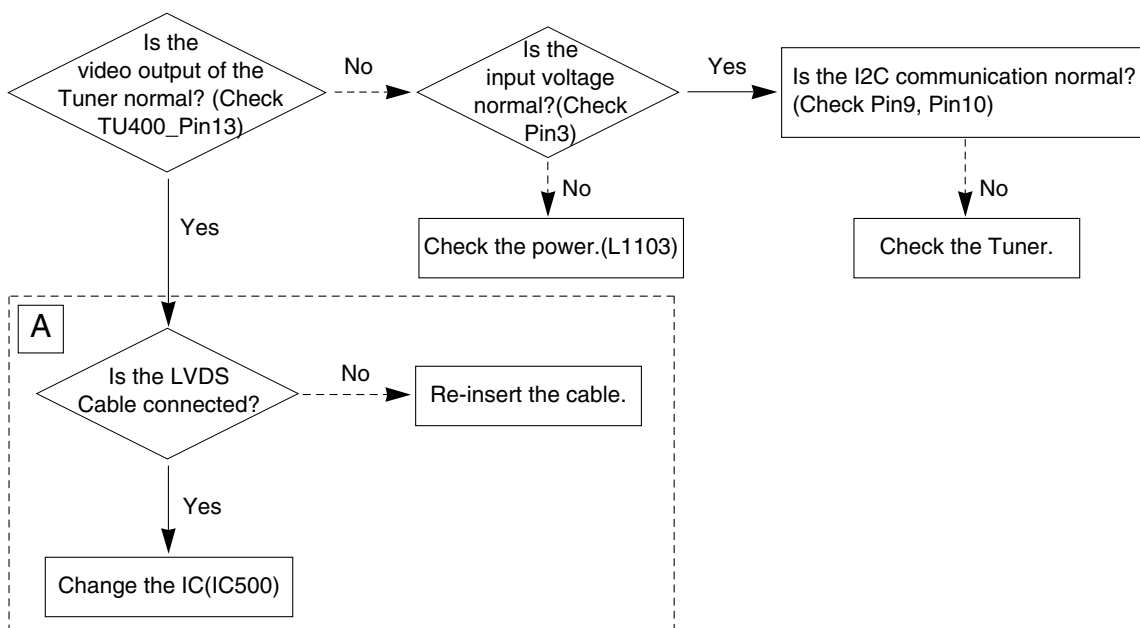

5. In the case of an unusual display in rear AV mode.

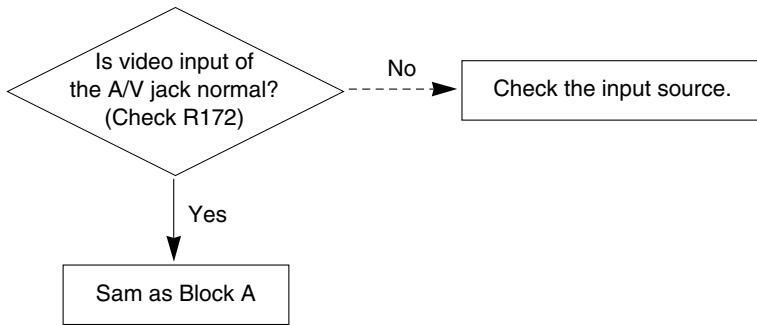

6. In the case of an unusual display in Side AV mode.

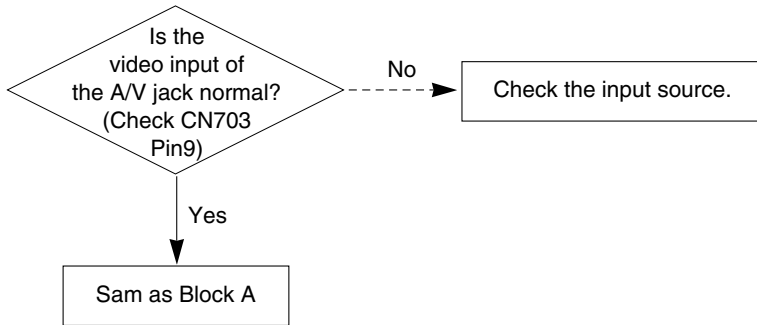

7. In the case of an unusual display in Side S-Video mode.

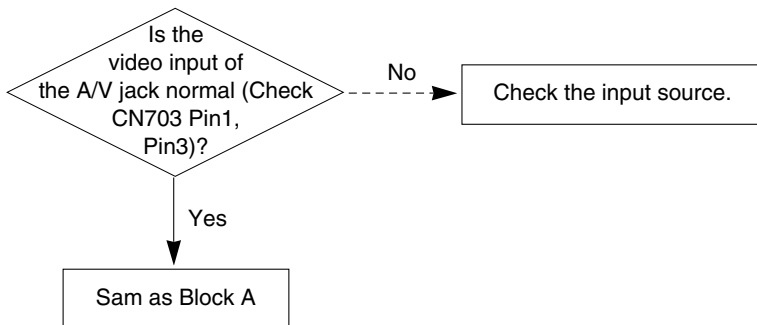

8. In the case of an unusual display in SCART 1 mode.

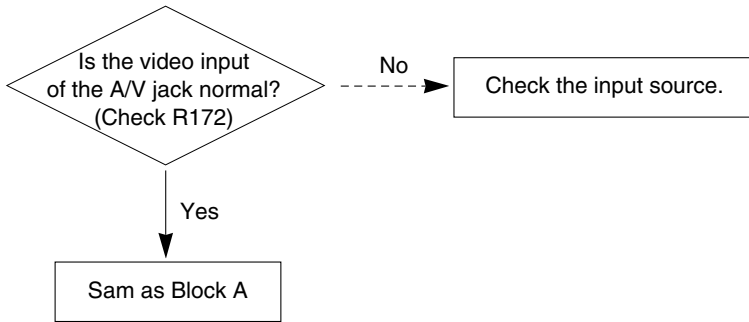

9. In the case of an unusual display in SCART 1_RGB mode.

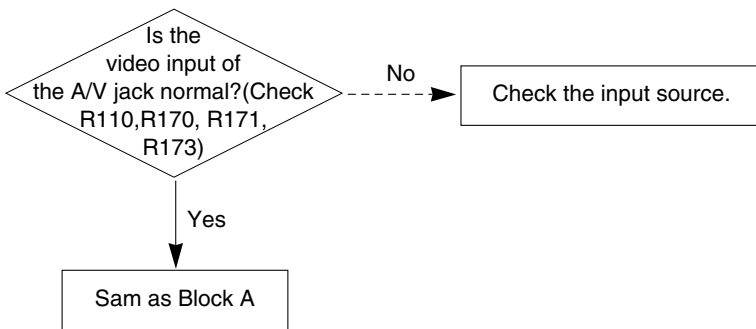

10. In the case of an unusual display in SCART 2 mode.

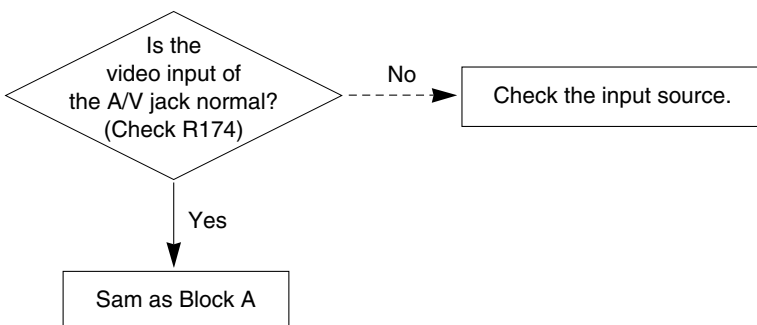

11. In the case of an unusual display in component 1 mode.

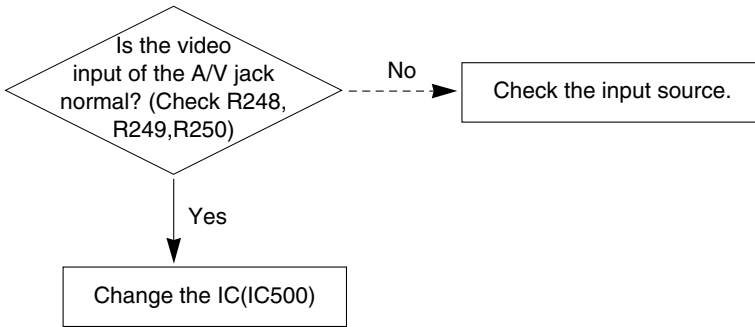

12. In the case of an unusual display in component 2 mode.

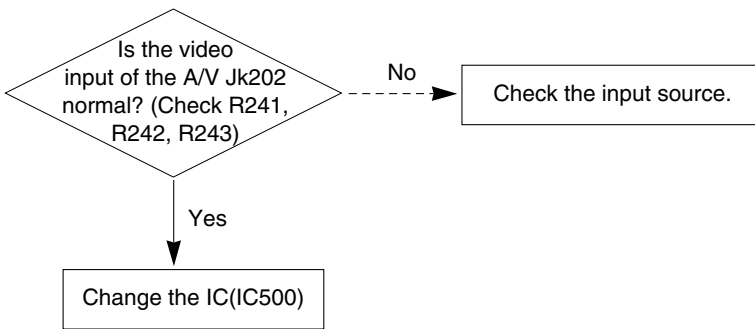

13. In the case of an unusual display in RGB mode.

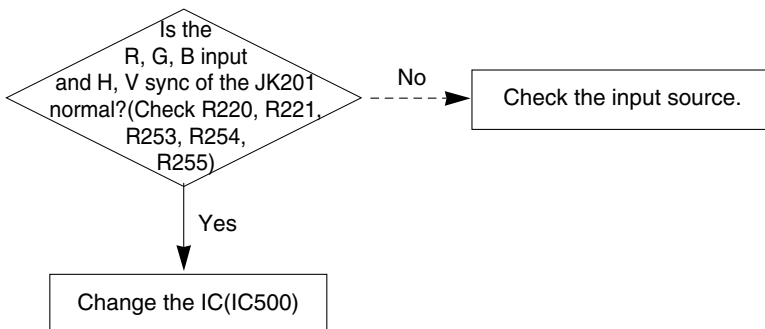

14. No Sound

(1) Symptom

- 1) LED is green.
- 2) There is a picture but no sound.

(2) Follow check

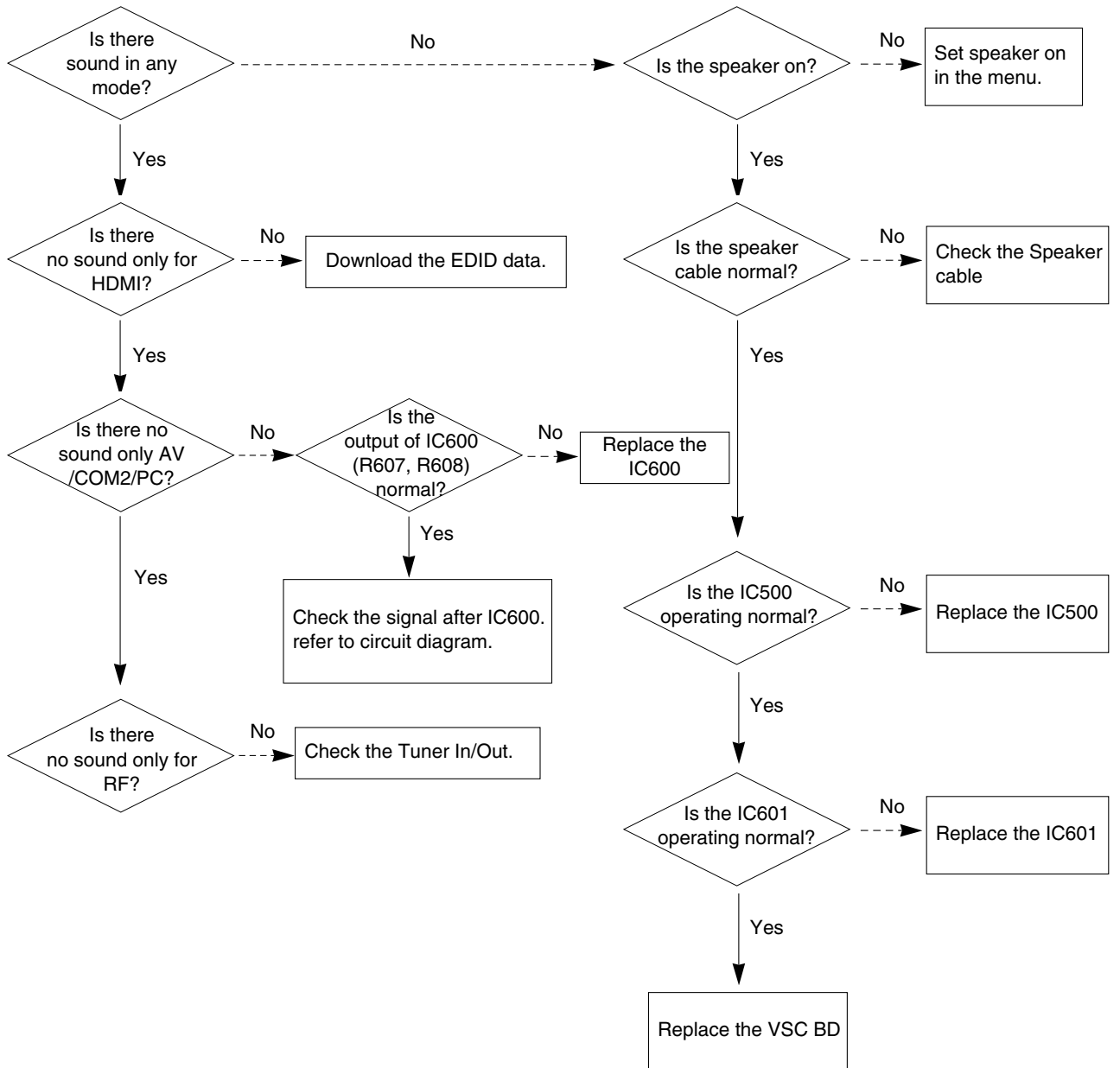

15. HDMI mode

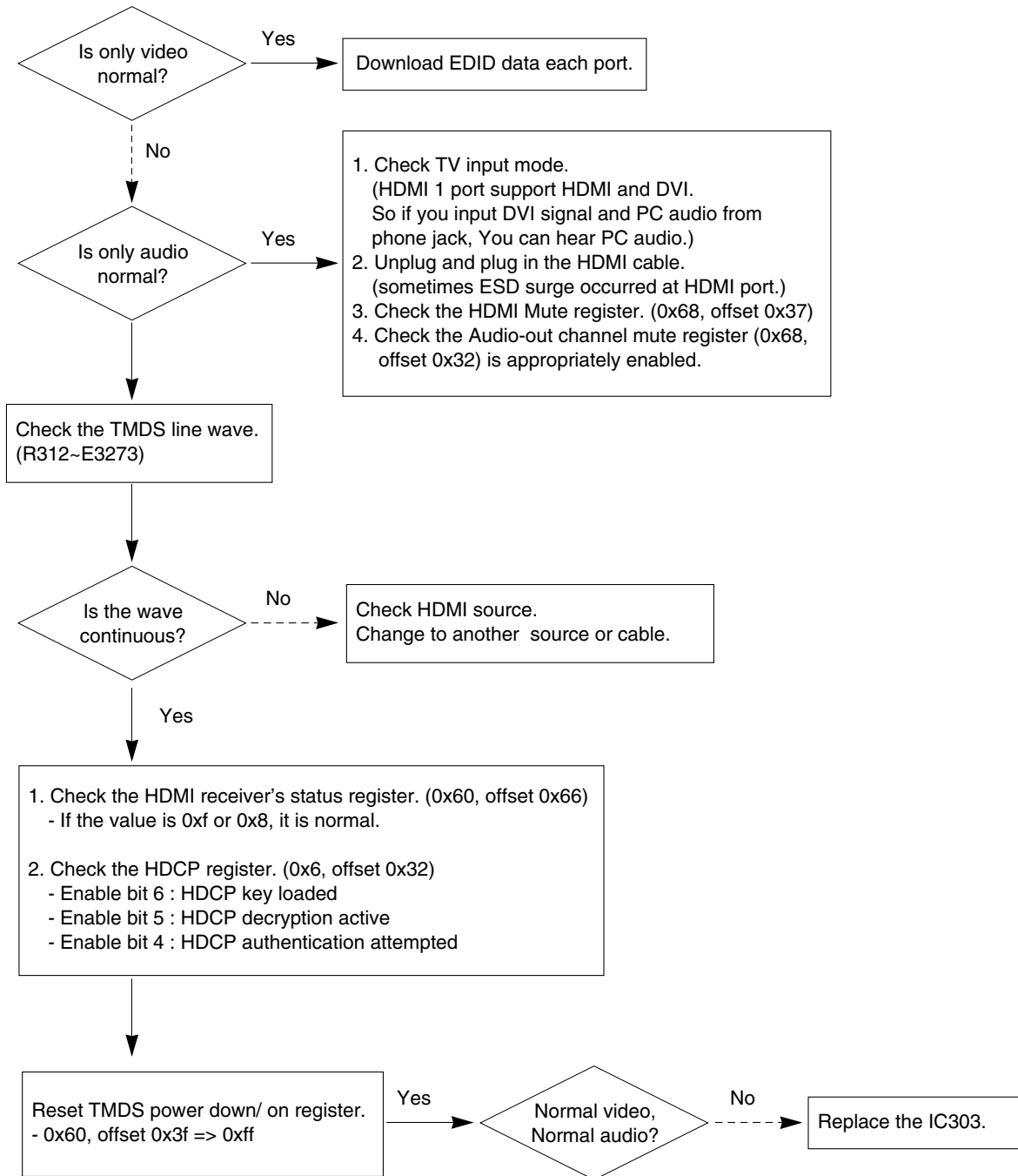

BLOCK DIAGRAM

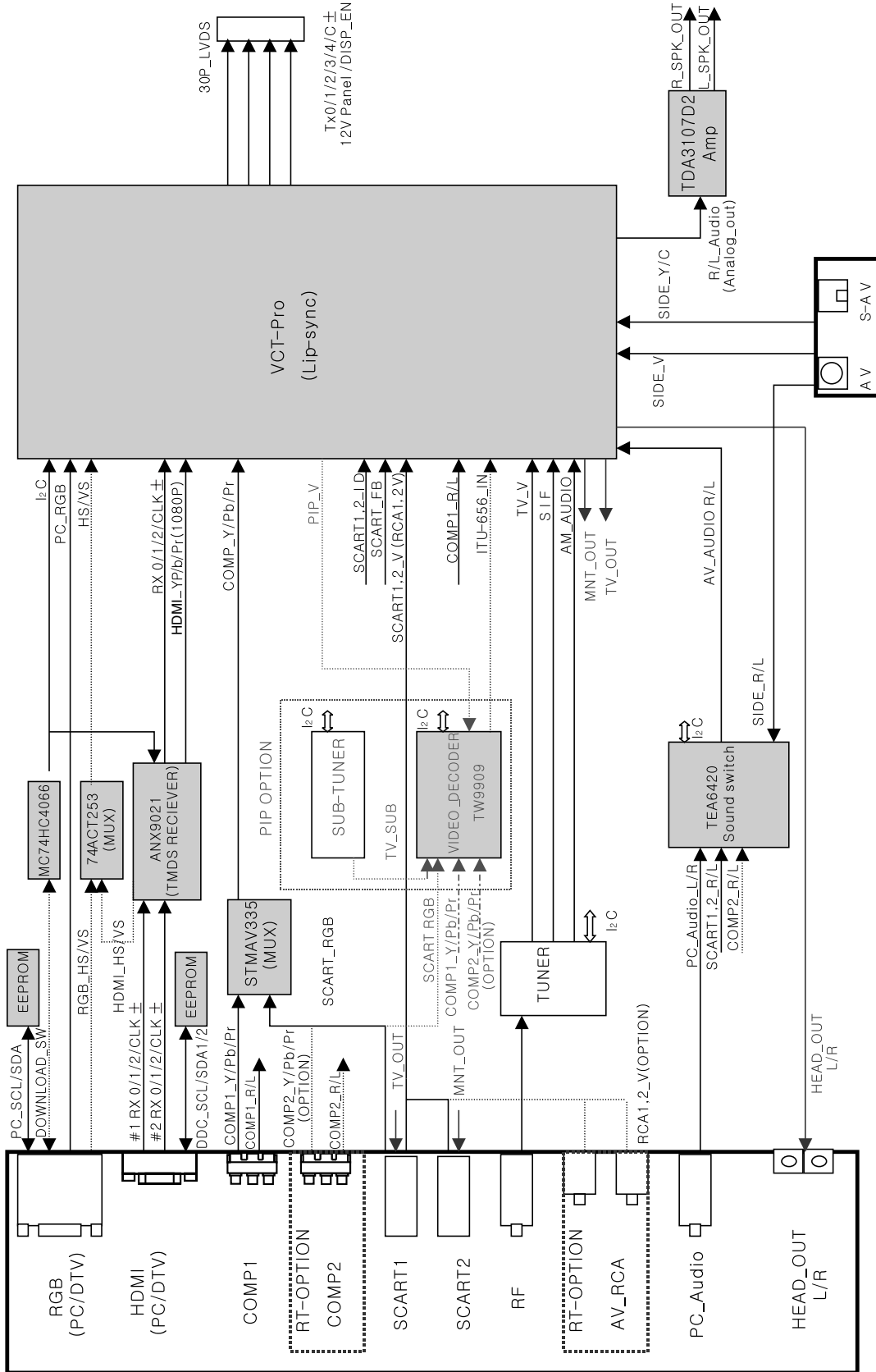

EXPLODED VIEW

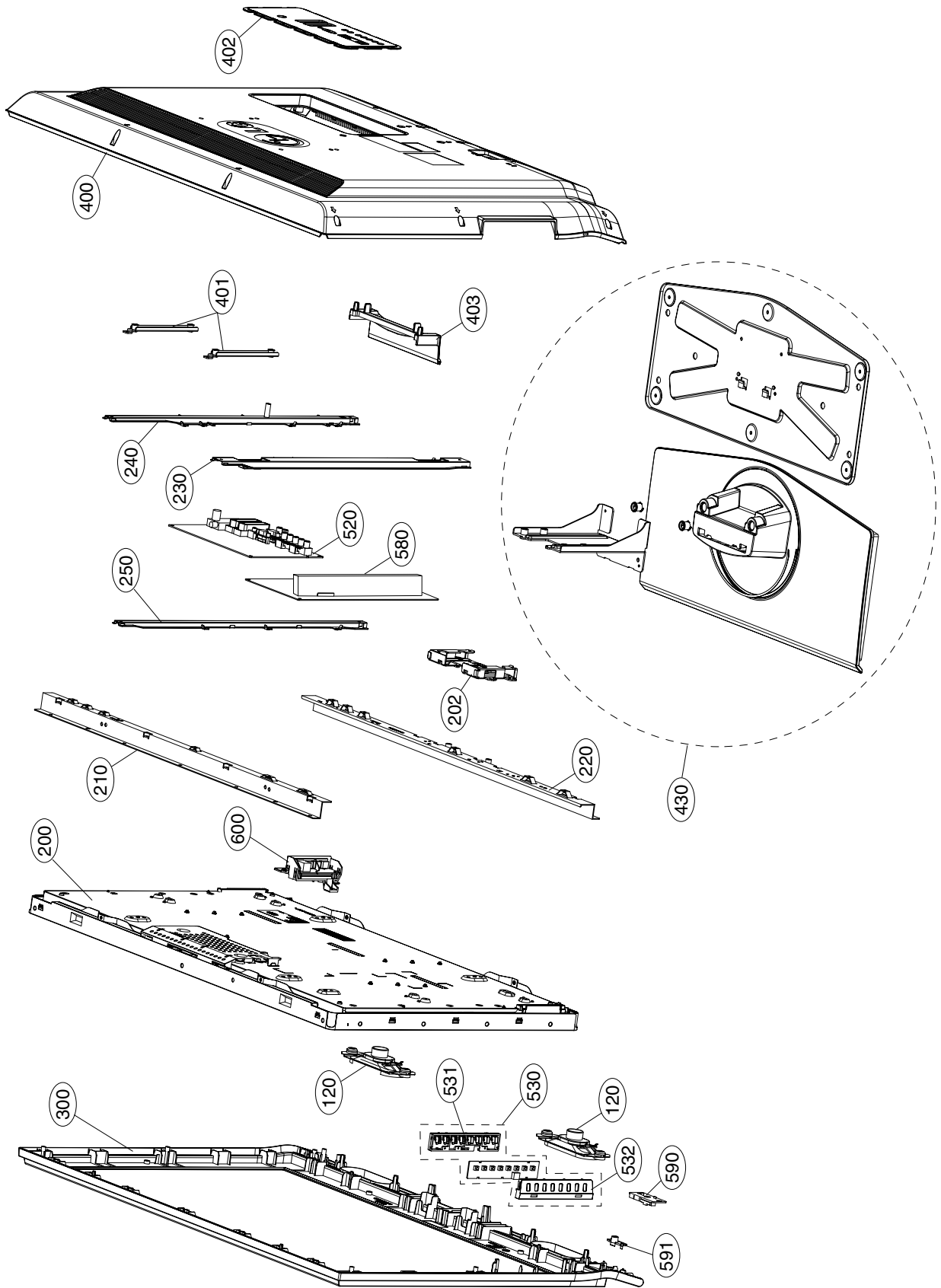

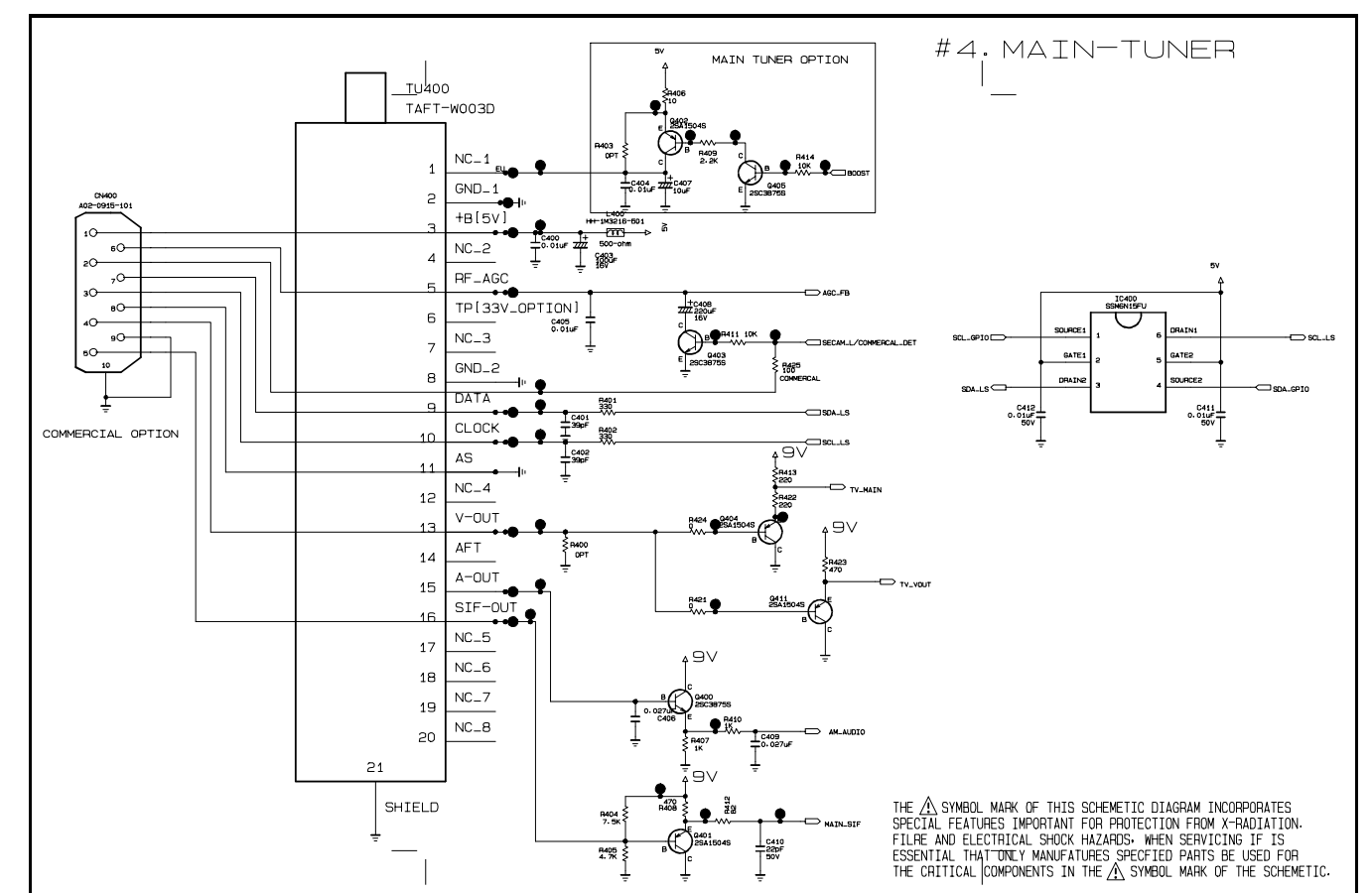
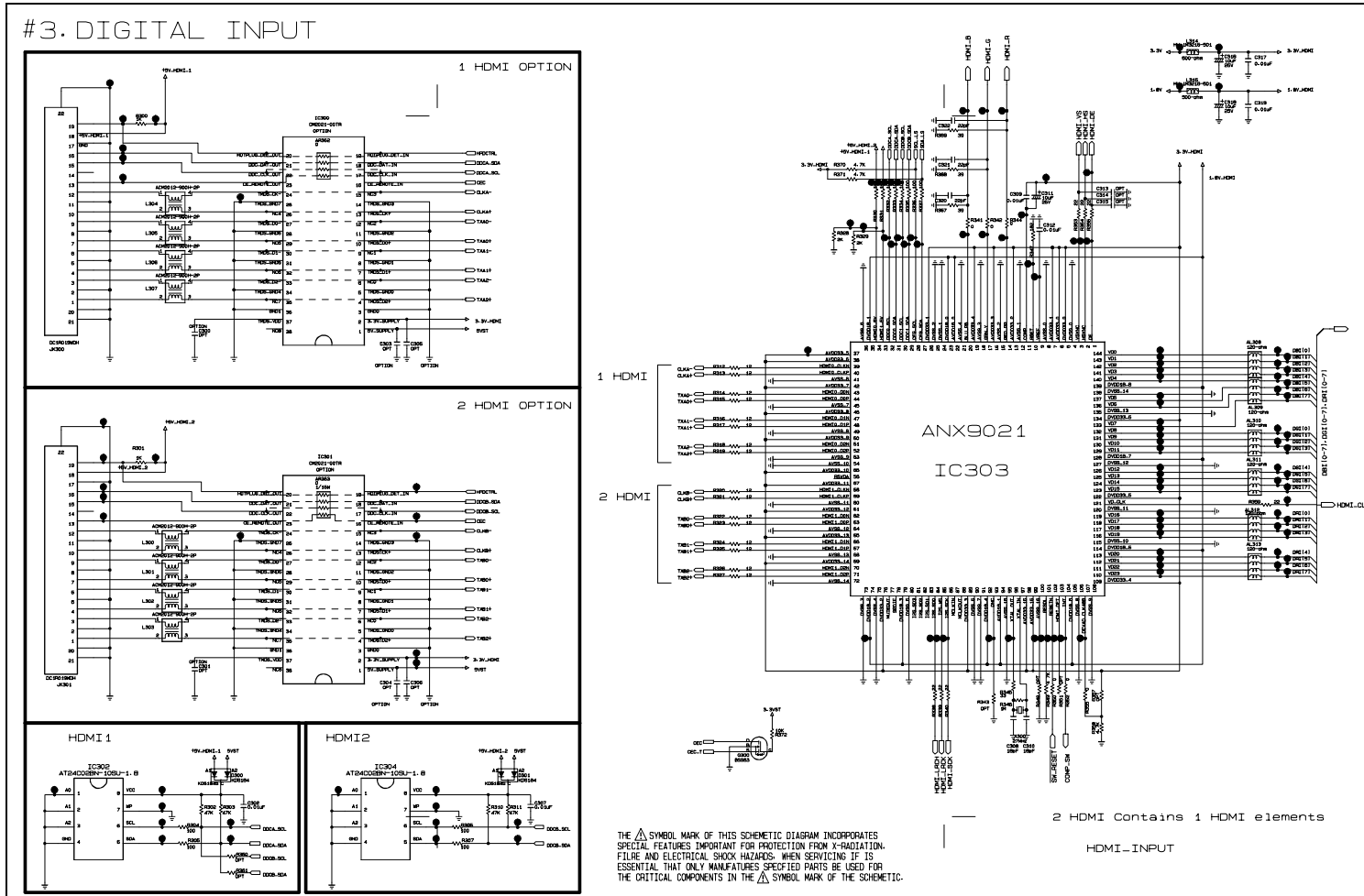
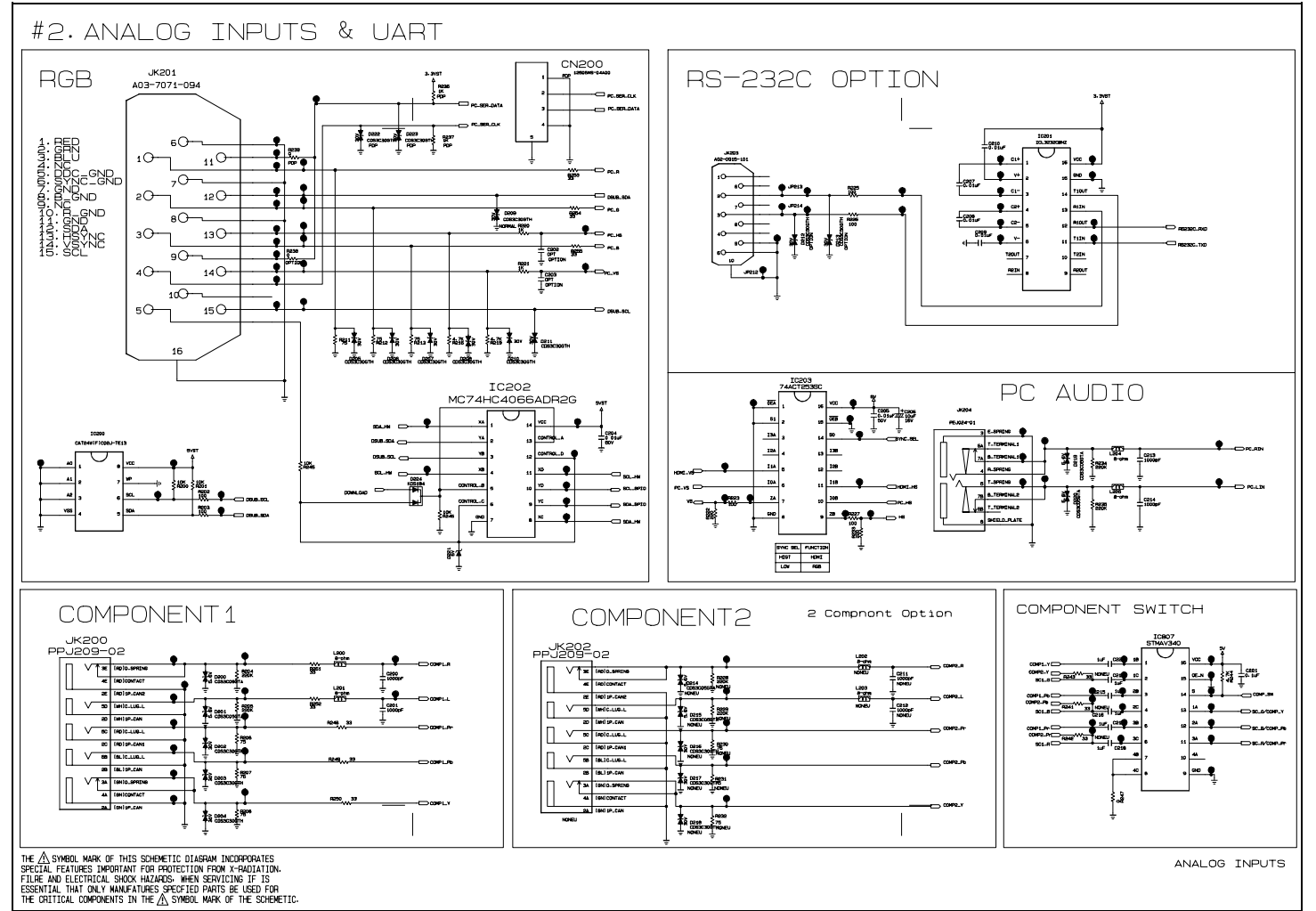
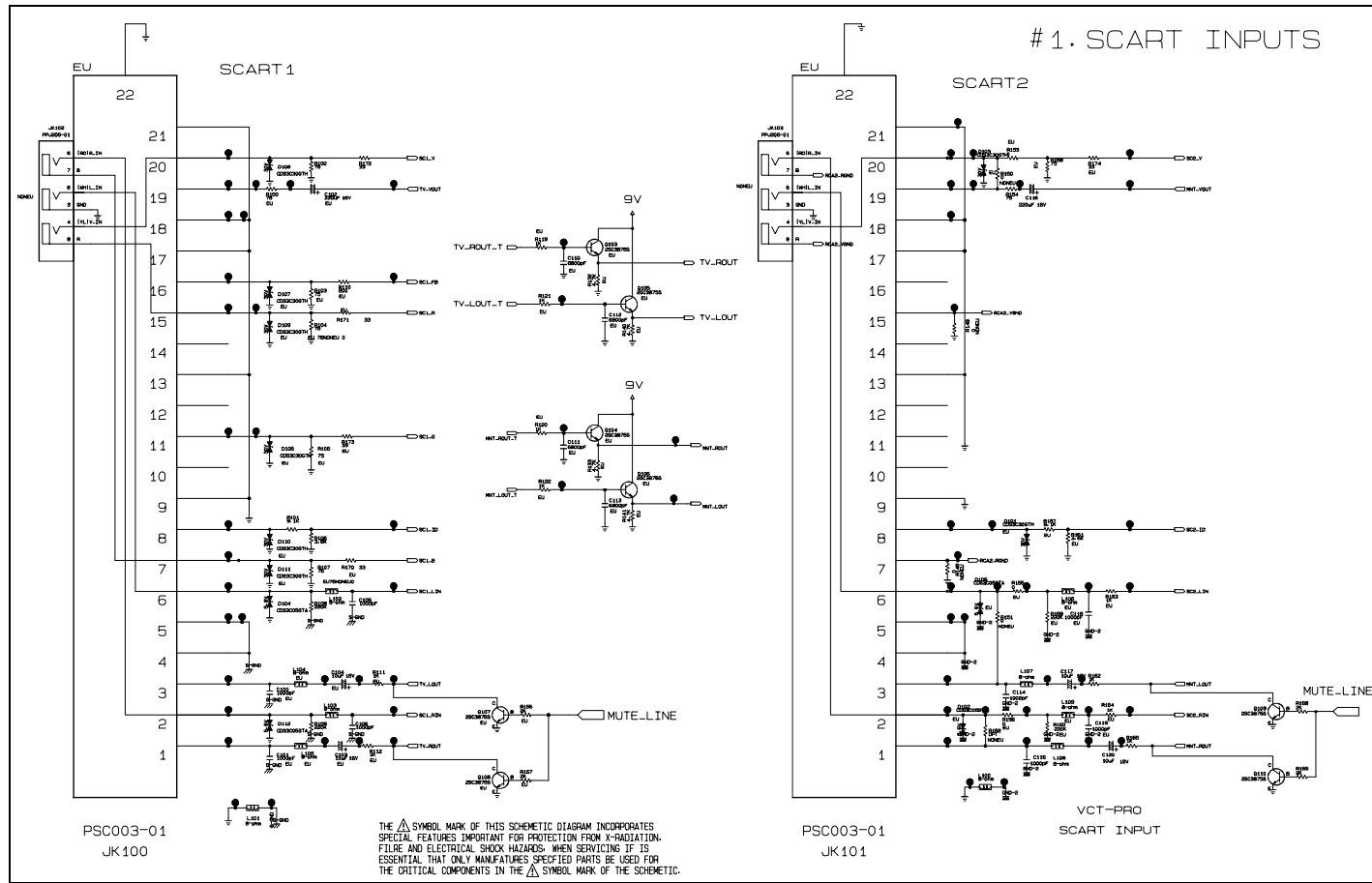

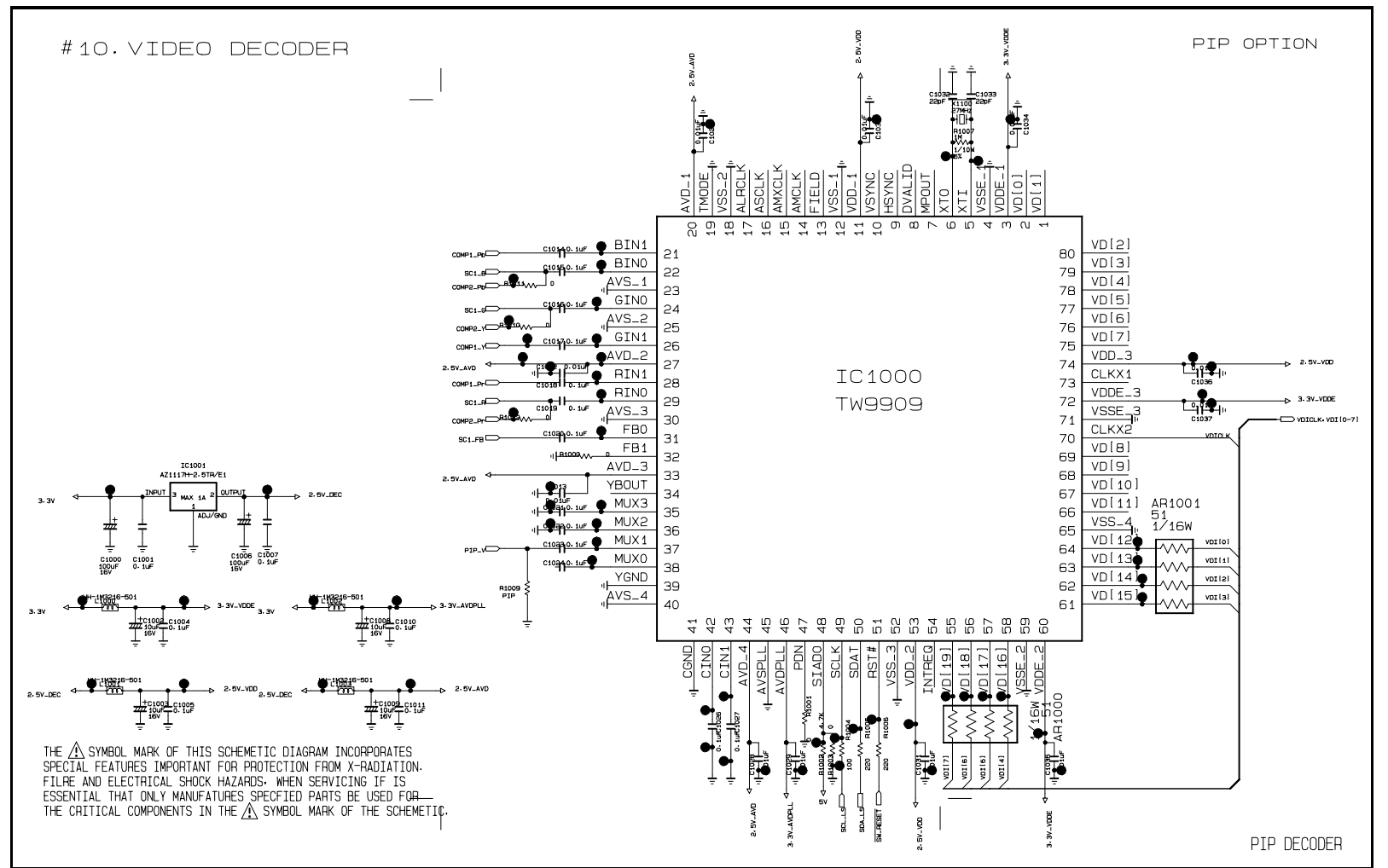
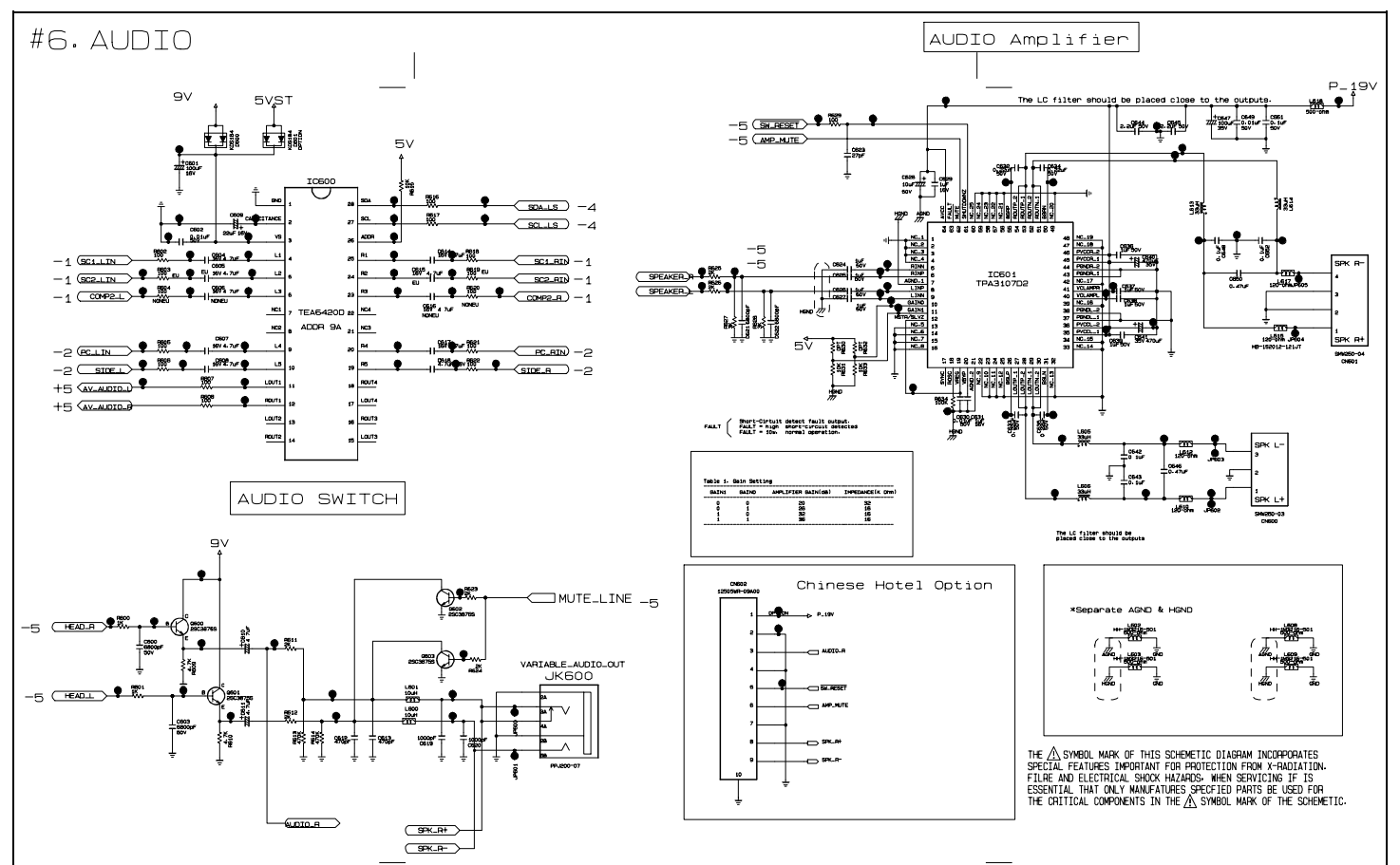
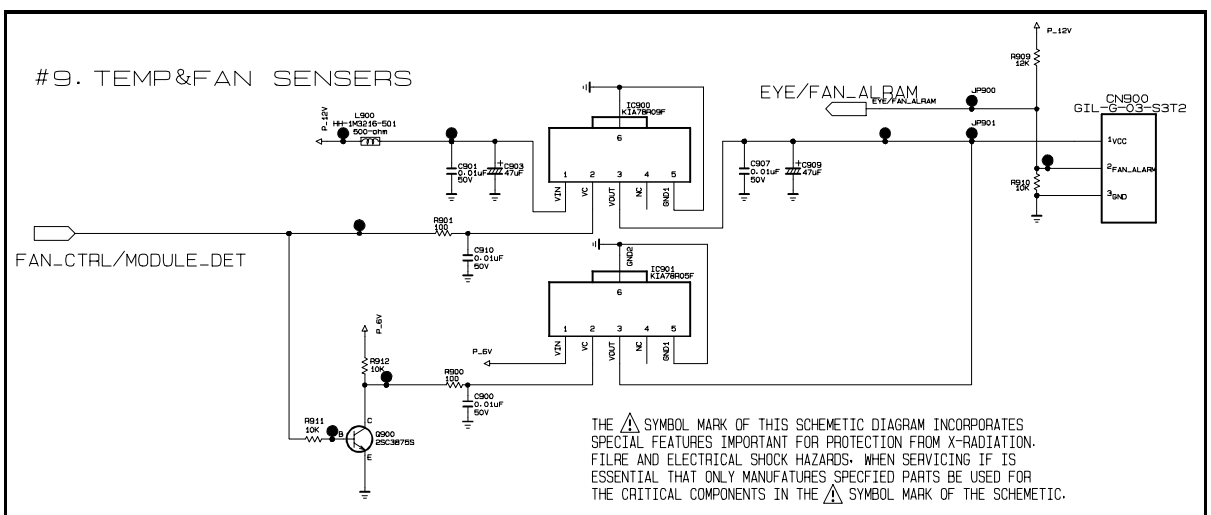
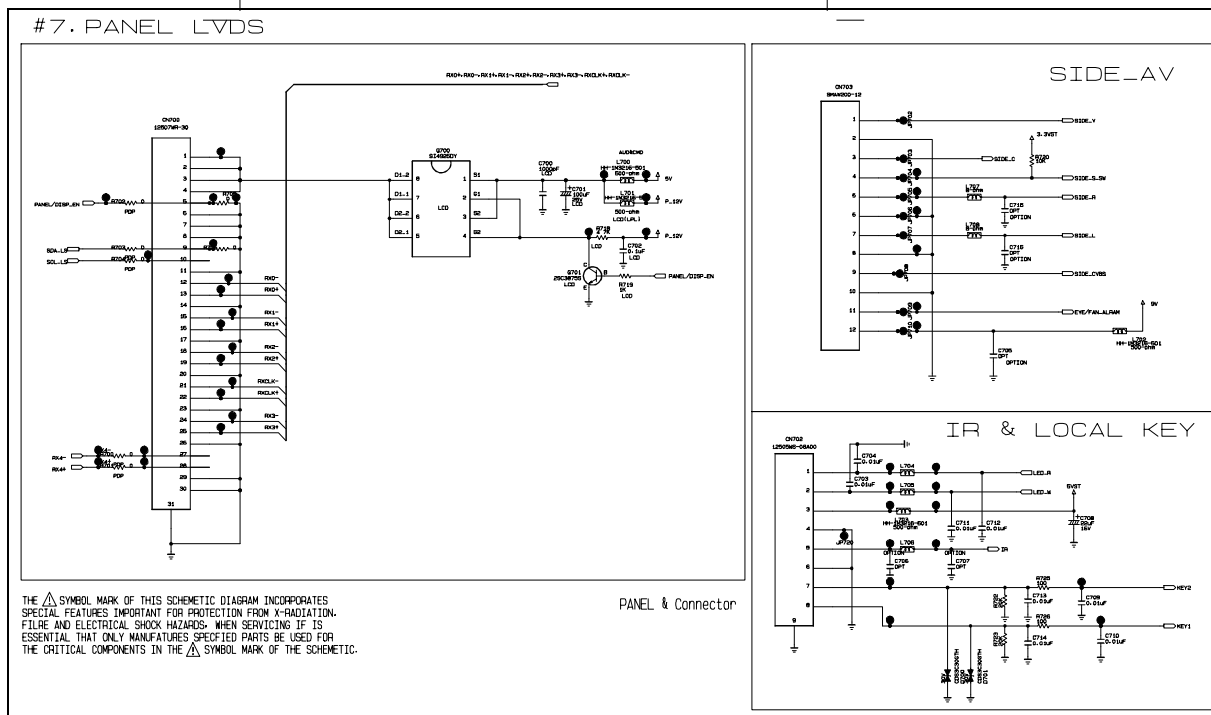
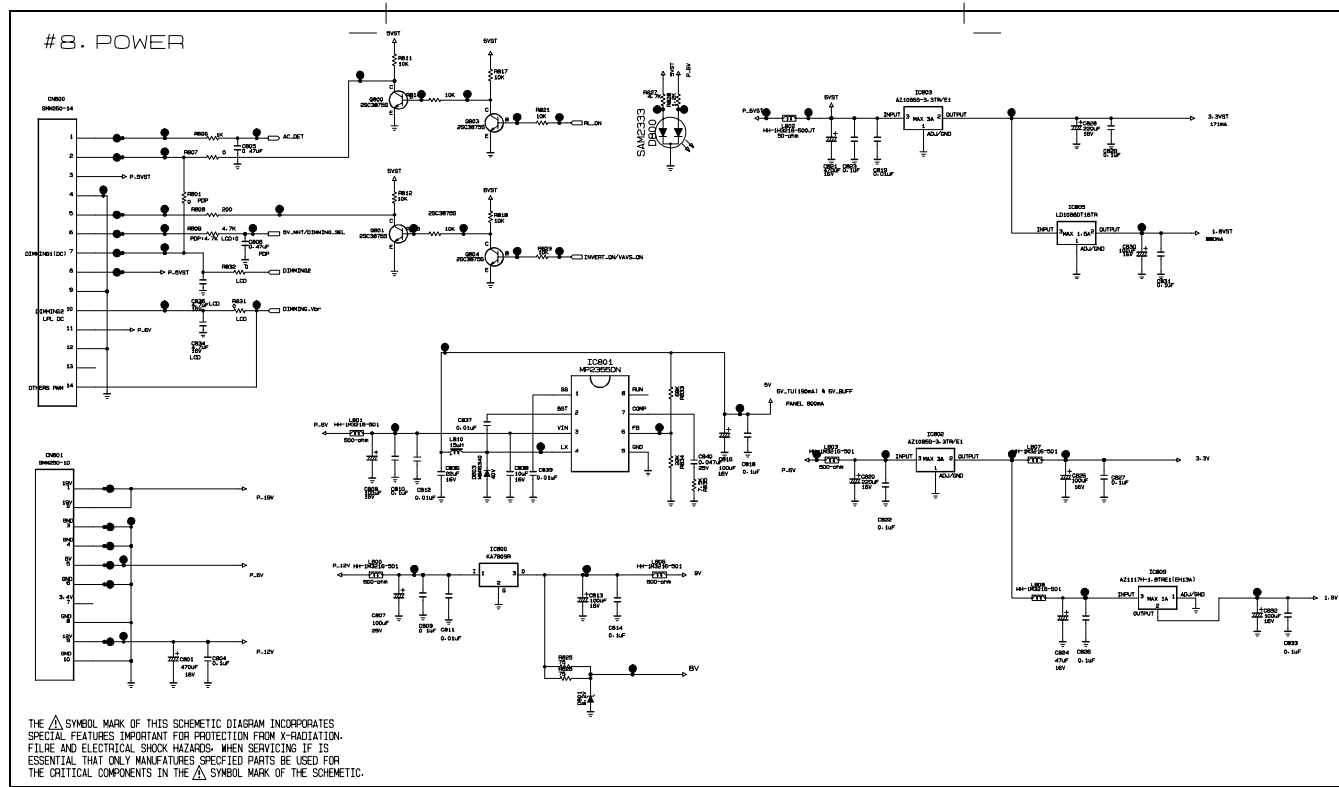

AUDIO Amplifier

The LC filter should be placed close to the outputs.

Table 1. Pin Setting

Pin	Setting	Function
1	1	SPK L+
2	2	SPK L-
3	3	SPK R+
4	4	SPK R-

The LC filter should be placed close to the outputs.

Chinese Hotel Option

*Separate AGND & HGND

THE Δ SYMBOL MARK OF THIS SCHEMATIC DIAGRAM INCORPORATES SPECIAL FEATURES IMPORTANT FOR PROTECTION FROM X-RADIATION, FILTRATION AND ELECTRICAL SHOCK HAZARDS. WHEN SERVICING IT IS ESSENTIAL THAT ONLY MANUFACTURERS SPECIFIED PARTS BE USED FOR THE CRITICAL COMPONENTS IN THE Δ SYMBOL MARK OF THE SCHEMATIC.

#5. VCTP

SCALER

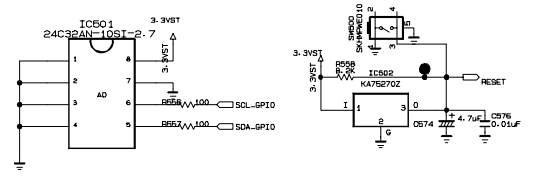
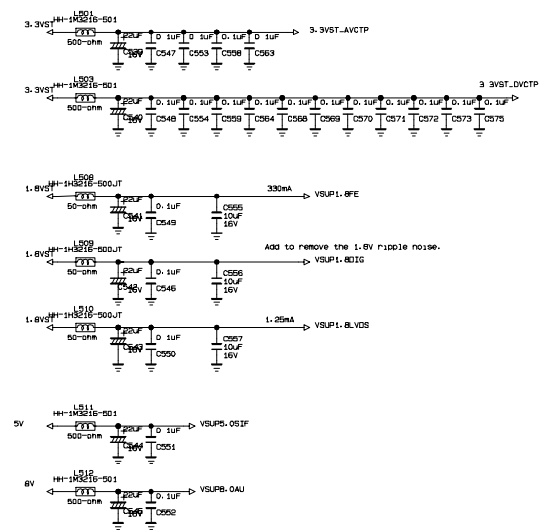
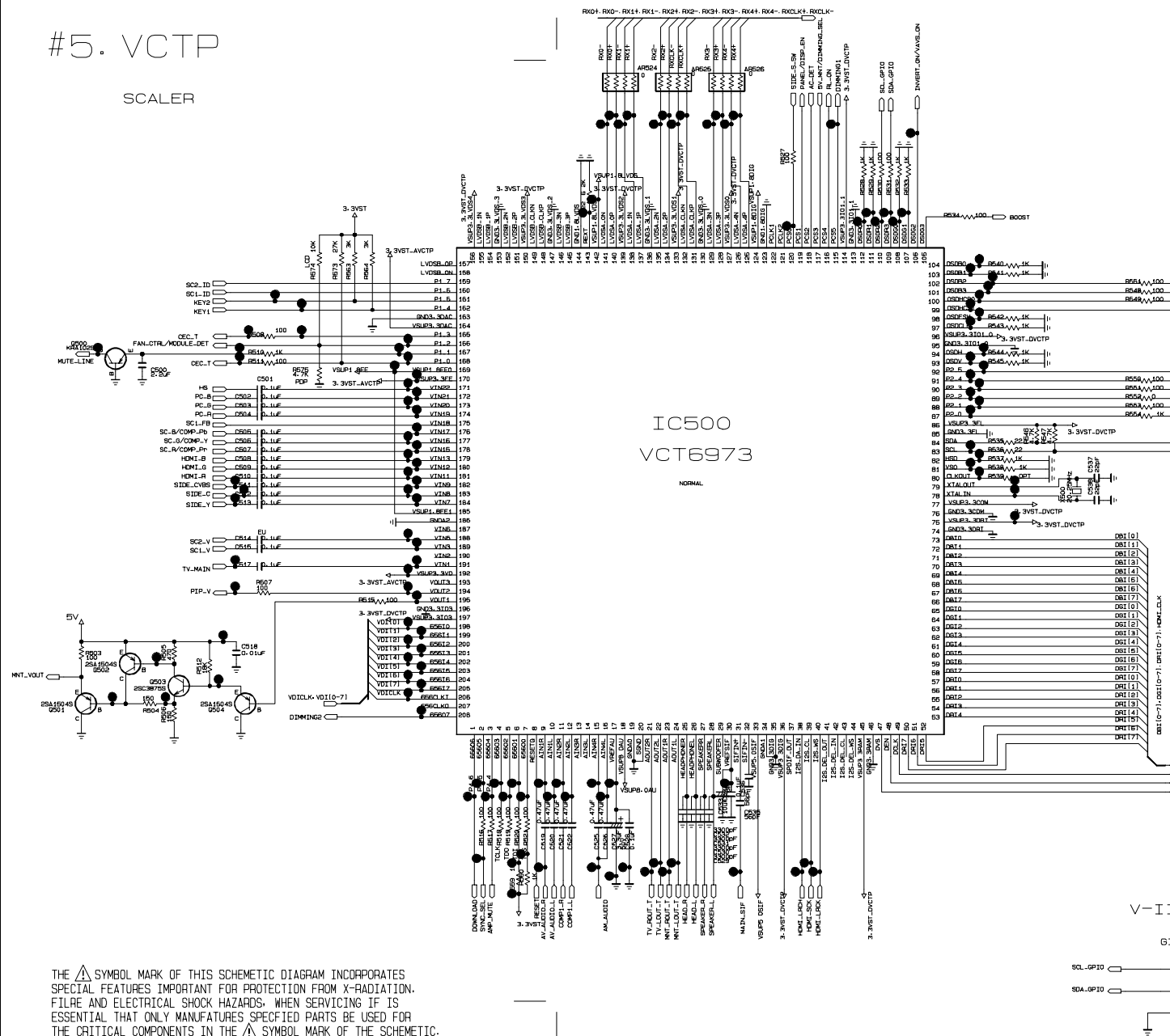

V-IIC OPTION

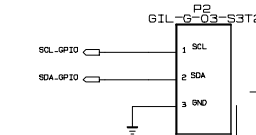

JTAG OPTION

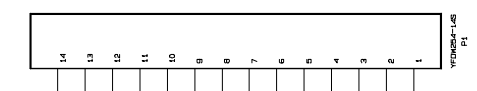

THE Δ SYMBOL MARK OF THIS SCHEMATIC DIAGRAM INCORPORATES SPECIAL FEATURES IMPORTANT FOR PROTECTION FROM X-RADIATION, FILRE AND ELECTRICAL SHOCK HAZARDS. WHEN SERVICING IF IS ESSENTIAL THAT ONLY MANUFACTURES SPECIFIED PARTS BE USED FOR THE CRITICAL COMPONENTS IN THE Δ SYMBOL MARK OF THE SCHEMATIC.



P/NO : MFL36696905

Mar., 2007
Printed in Korea

