

### General Description

The AP1610 SmartSwitch is a current limited P-channel MOSFET power switch designed for high-side load switching applications. This switch operates with inputs ranging from 2.4V to 5.5V, making it ideal for both 3V and 5V systems. An integrated current-limiting circuit protects the input supply against large currents which may cause the supply to fall out of regulation. The AP1610 is also protected from thermal overload which limits power dissipation and junction temperatures. It can be used to control loads that require up to 1A. Current limit threshold is programmed with a resistor from SET to ground. The quiescent supply current is typically a low 9 $\mu$ A. In shutdown mode, the supply current decreases to less than 1 $\mu$ A.

The AP1610 is available in a Pb-free 5-pin SOT23 or 8-pin SC70JW package and is specified over the -40°C to +85°C temperature range.

### Applications

- Hot Swap Supplies
- Notebook Computers
- Peripheral Ports
- Personal Communication Devices

### Features

- Input Voltage Range: 2.4V to 5.5V
- Programmable Over-Current Threshold
- Fast Transient Response:
  - 400ns Response to Short Circuit
- Low Quiescent Current
  - 9 $\mu$ A Typical
  - 1 $\mu$ A Max with Switch Off
- 200m $\Omega$  Typical  $R_{DS(ON)}$
- Only 2.5V Needed for ON/OFF Control
- Under-Voltage Lockout
- Thermal Shutdown
- 4kV ESD Rating
- 5-Pin SOT23
- Temperature Range: -40°C to +85°C

### Typical Application

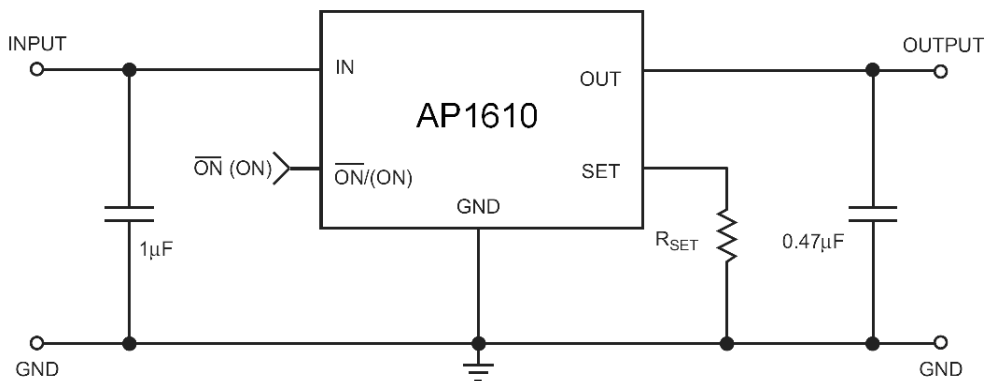

### Pin Configuration

SOT23-5L

(Top View)

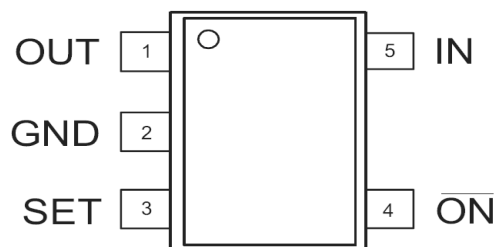

## Pin Descriptions

Pin Number	Symbol	Function
1	OUT	P-channel MOSFET drain. Connect a 0.47 $\mu$ F capacitor from OUT to GND.
2	GND	Ground connection.
3	SET	Current limit set input. A resistor from SET to ground sets the current limit for the switch.
4	ON	Enable input. Two versions are available, active-high and active-low. See Ordering Information for details.
5	IN	P-channel MOSFET source. Connect a 1 $\mu$ F capacitor from IN to GND.

## Absolute Maximum Ratings

T<sub>A</sub> = 25°C, unless otherwise noted

Symbol	Description	Value	Units
V <sub>IN</sub>	IN to GND	-0.3 to 7	V
V <sub>ON</sub>	ON( $\overline{ON}$ ) to GND	-0.3 to V <sub>IN</sub> + 0.3	V
V <sub>SET</sub> , V <sub>OUT</sub>	SET, OUT to GND	-0.3 to V <sub>IN</sub> + 0.3	V
I <sub>MAX</sub>	Maximum Continuous Switch Current	2	A
T <sub>J</sub>	Operating Junction Temperature Range	-40 to 150	°C
T <sub>LEAD</sub>	Maximum Soldering Temperature (at Leads)	300	°C
V <sub>ESD</sub>	ESD Rating <sup>1</sup> - HBM	4000	V

## Thermal Characteristics<sup>2</sup>

Symbol	Description	Value	Units
$\Theta_{JA}$	Thermal Resistance	150	°C/W
P <sub>D</sub>	Power Dissipation	667	mW

Stresses above those listed in Absolute Maximum Ratings may cause permanent damage to the device. Functional operation at conditions other than the operating conditions specified is not implied. Only one Absolute Maximum Rating should be applied at any one time.

1. Human body model is a 100pF capacitor discharged through a 1.5k $\Omega$  resistor into each pin.
2. Mounted on a demo board.

## Electrical Characteristics

$V_{IN} = 5V$ ,  $T_A = -40^{\circ}C$  to  $+85^{\circ}C$ , unless otherwise noted. Typical values are  $T_A = 25^{\circ}C$

Symbol	Description	Conditions	Min	Typ	Max	Units
$V_{IN}$	Operation Voltage		2.4		5.5	V
$I_Q$	Quiescent Current	$V_{IN} = 5V$ , $ON(\overline{ON}) = \text{Active}$ , $I_{OUT} = 0$		7	25	$\mu A$
$I_{Q(OFF)}$	Off Supply Current	$ON(\overline{ON}) = \text{Inactive}$ , $V_{IN} = 5.5V$			1	$\mu A$
$I_{SD(OFF)}$	Off Switch Current	$ON(\overline{ON}) = \text{Inactive}$ , $V_{IN} = 5.5V$ , $V_{OUT} = 0$		0.01	1	$\mu A$
$V_{UVLO}$	Under-Voltage Lockout	Rising Edge, 1% Hysteresis		1.8	2.4	V
$R_{DS(ON)}$	On Resistance	$V_{IN} = 5.0V$ , $T_A = 25^{\circ}C$		200		m $\Omega$
		$V_{IN} = 4.5V$ , $T_A = 25^{\circ}C$		210		
		$V_{IN} = 3.0V$ , $T_A = 25^{\circ}C$		250		
$TC_{RDS}$	On Resistance Temperature Coefficient			2800		ppm/ $^{\circ}C$
$I_{LIM}$	Current Limit	$R_{SET} = 6.8k\Omega$	0.75	1	1.25	A
$I_{LIM(MIN)}$	Minimum Current Limit			130		mA
$V_{ON(L)}$	$ON(\overline{ON})$ Input Low Voltage	$V_{IN} = 2.7V$ to $5.5V$			0.8	V
$V_{ON(H)}$	$ON(\overline{ON})$ Input High Voltage	$V_{IN} = 2.7V$ to $< 4.2V$	2.0			
		$V_{IN} \geq 4.2V$ to $5.0V$	2.4			
$I_{ON(SINK)}$	$ON(\overline{ON})$ Input Leakage	$V_{ON} = 5.5V$		0.01	1	$\mu A$
$T_{RESP}$	Current Limit Response Time	$V_{IN} = 5V$		50		$\mu s$
$T_{OFF}$	Turn-Off Time	$V_{IN} = 5V$ , $R_L = 10\Omega$		10	16	$\mu s$
$T_{ON}$	Turn-On Time	$V_{IN} = 5V$ , $R_L = 10\Omega$		14	200	$\mu s$
$T_{SD}$	Over-Temperature Threshold	$V_{IN} = 5V$	$T_J$ Increasing		125	$^{\circ}C$
			$T_J$ Decreasing		115	

## Typical Characteristics

Unless otherwise noted,  $V_{IN} = 5V$ ,  $T_A = 25^{\circ}C$ .

Quiescent Current vs. Temperature

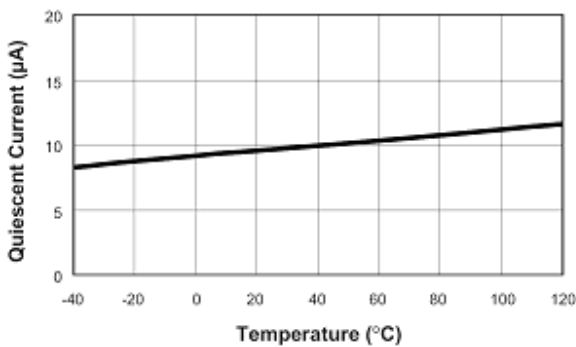

Quiescent Current vs VIN

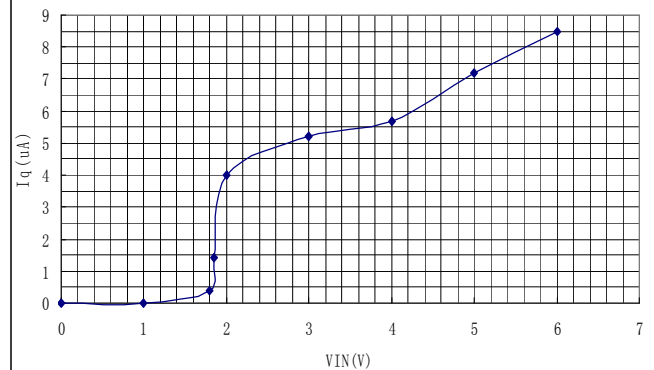

Off-Supply Current vs. Temperature

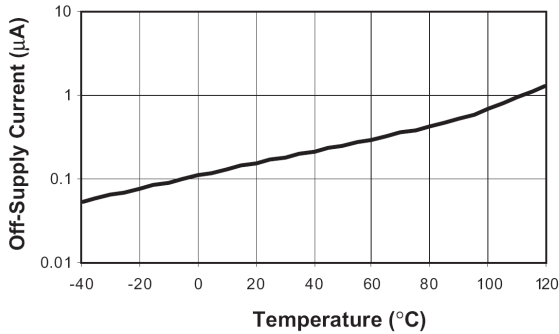

Off-Switch Current vs. Temperature

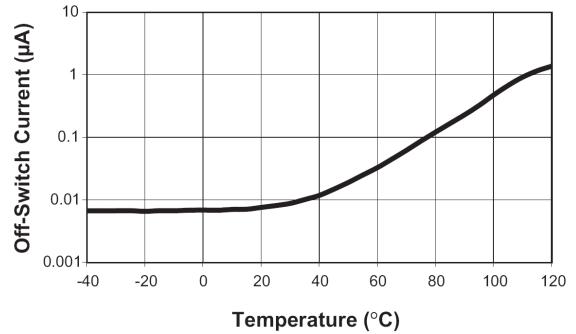

Turn-On vs. Temperature  
( $R_{LOAD} = 10\Omega$ ;  $C_{LOAD} = 0.47\mu F$ )

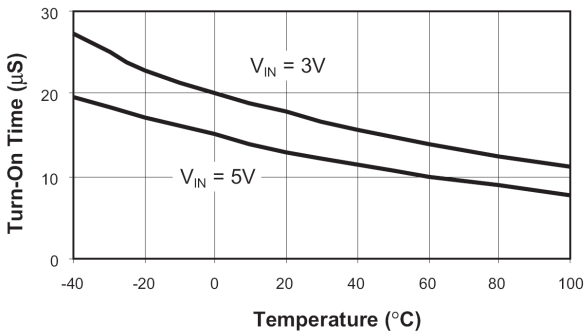

Turn-Off vs. Temperature  
( $R_{LOAD} = 10\Omega$ ;  $C_{LOAD} = 0.47\mu F$ )

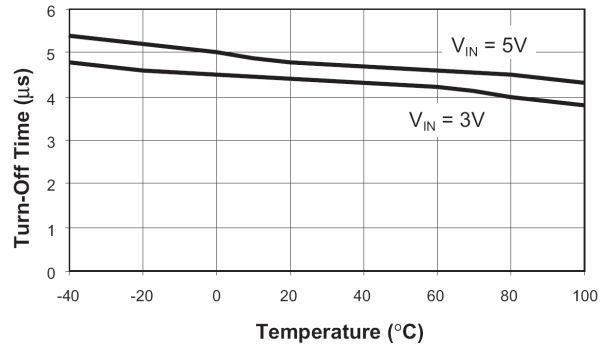

$V_{IN}=5V, R_L=10\Omega, R_c=0.47\mu F$  ( Channel13=VEN, Channel12=VO )

Turn on



Turn off

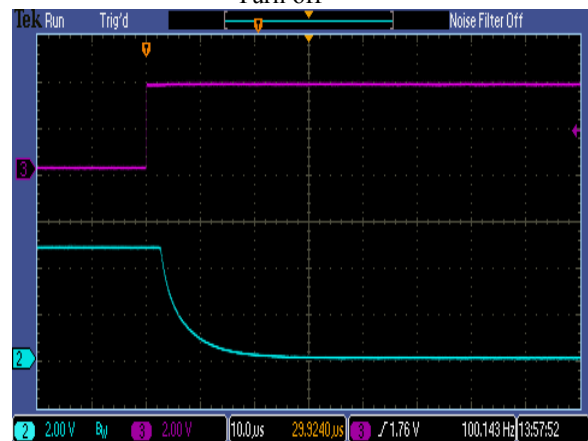

Short circuit to GND

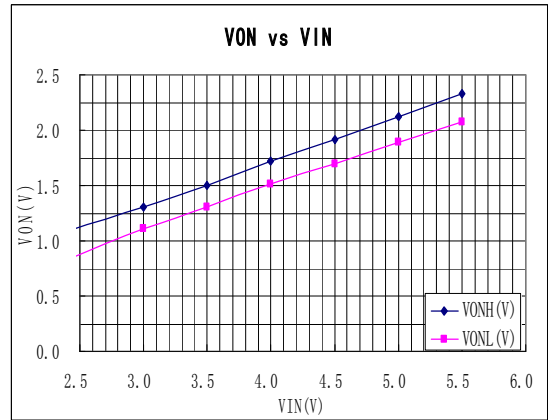
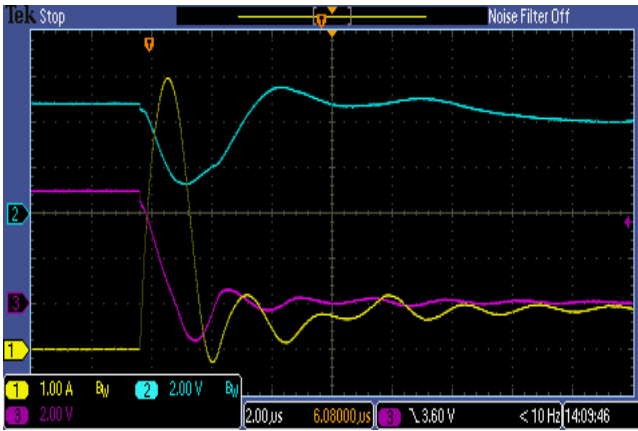

Channel1=IO,Channel2=Vin,Channel3=Vo

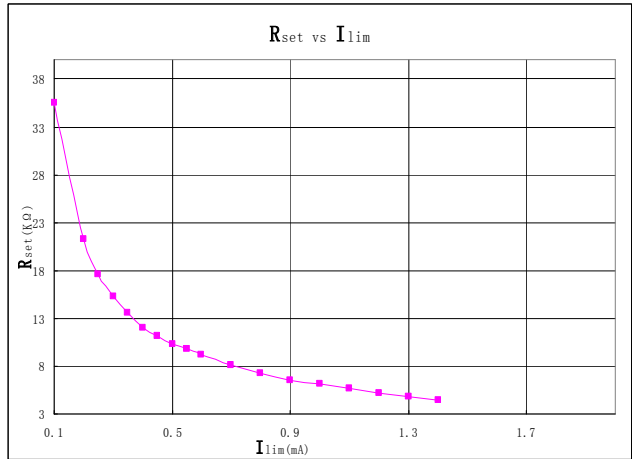
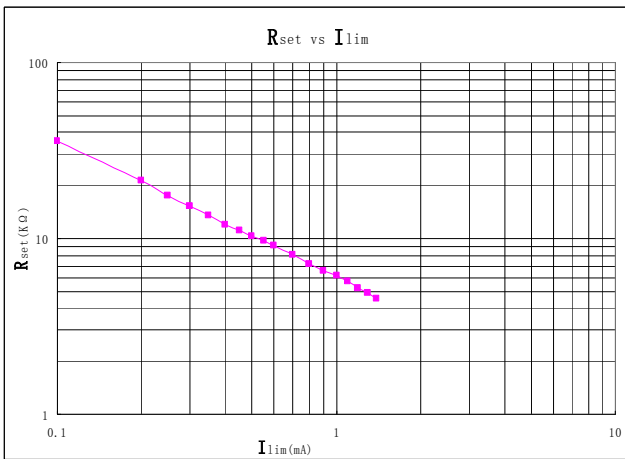

## Functional Block Diagram

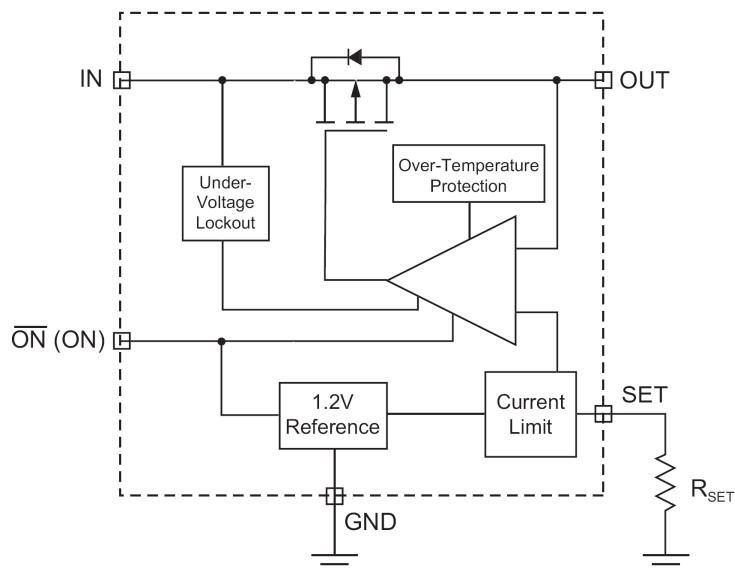

## Application Information

### Setting Current Limit

In most applications, the variation in  $I_{LIM}$  must be taken into account when determining  $R_{SET}$ . The  $I_{LIM}$  variation is due to processing variations from part to part, as well as variations in the voltages at IN and OUT, plus the operating temperature. These three factors add up to a  $\pm 25\%$  tolerance. Figure 1 illustrates a cold device with a statistically higher current limit and a hot device with a statistically lower current limit, both with  $R_{SET}$  equal to 8.08k $\Omega$ . While the chart, " $R_{SET}$  vs.  $I_{LIM}$ " indicates an  $I_{LIM}$  of 0.7A with an  $R_{SET}$  of 8.08k $\Omega$ , this figure shows that the actual current limit will be at least 0.525A and no greater than 0.880A.

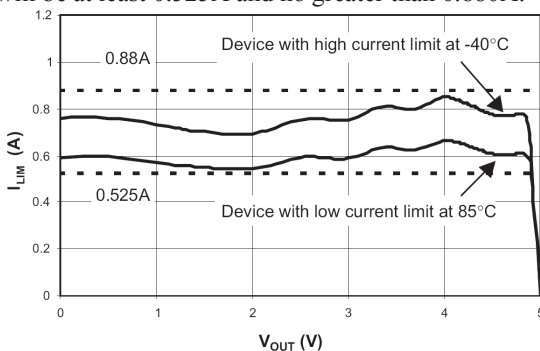

Figure 1: Current Limit Using 8.08k $\Omega$ .

To determine  $R_{SET}$ , start with the maximum current drawn by the load and multiply it by 1.33 (typical  $I_{LIM} = \text{minimum } I_{LIM} / 0.75$ ). This is the typical current limit value. Next, refer to " $R_{SET}$  vs.  $I_{LIM}$ " and find the  $R_{SET}$  that corresponds to the typical current limit value. Choose the largest resistor available that is less than or equal to it. For greater precision, the value of  $R_{SET}$  may also be calculated using the  $I_{LIM} R_{SET}$  product found in the chart " $R_{SET}$  Coefficient vs.  $I_{LIM}$ ". The maximum current is derived by multiplying the typical current for the chosen  $R_{SET}$  in the chart by 1.25. A few standard resistor values are listed in the table "Current Limit  $R_{SET}$  Values."

### Current Limit $R_{SET}$ Values

RSET (k $\Omega$ )	Current Limit Typ (mA)	Device Will Not Current Limit Below (mA)	Device Always Current Limits Below (mA)
21.3	200	150	250
17.58	250	188	313
15.25	300	225	375
13.55	350	263	438
12.04	400	300	500
11.2	450	338	563
10.35	500	375	625

9.76	550	413	688
9.15	600	450	750
8.08	700	525	875
7.22	800	600	1000
6.58	900	675	1125
6.12	1000	750	1250
5.68	1100	825	1375
5.24	1200	900	1500
4.87	1300	975	1625
4.52	1400	1050	1750

Example: A USB port requires 0.5A. 0.5A multiplied by 1.33 is 0.665A. From the chart named " $R_{SET}$  vs.  $I_{LIM}$ ",  $R_{SET}$  should be less than 9.15k $\Omega$ . 8.08k $\Omega$  is a standard value that is a little less than 9.15k $\Omega$  but very close. The chart reads approximately 0.700A as a typical  $I_{LIM}$  value for 8.08k $\Omega$ . Multiplying 0.700A by 0.75 and 1.25 shows that the AP1610 will limit the load current to greater than 0.525A but less than 0.875A.

### Operation in Current Limit

When a heavy load is applied to the output of the AP1610, the load current is limited to the value of  $I_{LIM}$  determined by  $R_{SET}$ . See Figure 2, "Overload Operation." Since the load is demanding more current than  $I_{LIM}$ , the voltage at the output drops. This causes the AP1610 to dissipate a larger than normal quantity of power, and its die temperature to increase. When the die temperature exceeds an over-temperature limit, the AP1610 will shut down until it has cooled sufficiently, at which point it will startup again. The AP1610 will continue to cycle on and off until the load is removed, power is removed, or until a logic high level is applied to ON.

### Enable Input

In many systems, power planes are controlled by integrated circuits which run at lower voltages than the power plane itself. The enable input ON of the AP1610 has low and high threshold voltages that accommodate this condition. The threshold voltages are compatible with 5V TTL and 2.5V to 5V CMOS.

### Reverse Voltage

The AP1610 is designed to control current flowing from IN to OUT. If a voltage is applied to OUT which is greater than the voltage on IN, large currents may flow. This could cause damage to the AP1610.

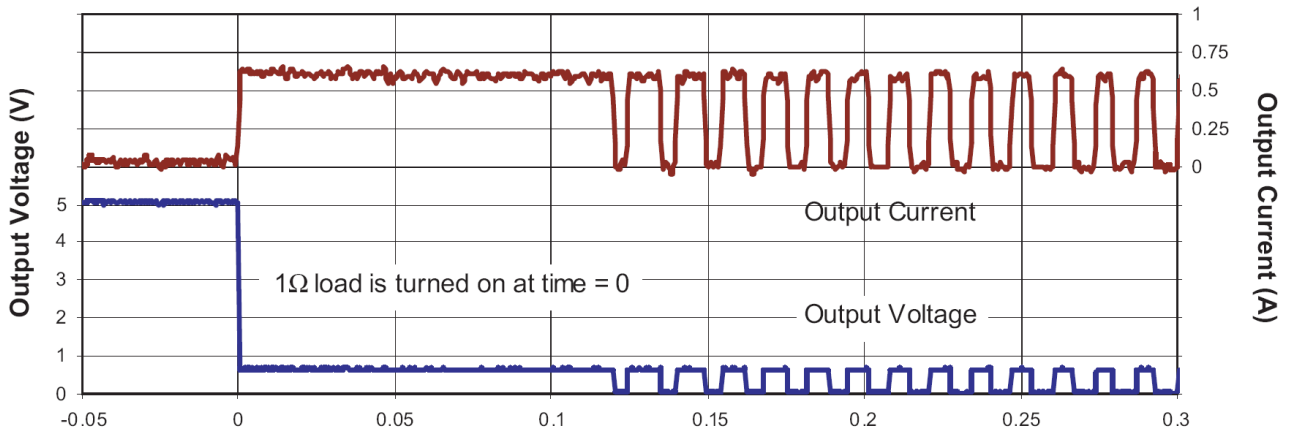

Figure 2: Overload Operation

### Ordering Information

Part Number	Top Mark	Package	Description
AP1610ES5-LFKR	I1XY	SOT23-5L	Low Level Active
AP1610ES5-HFKR	I2XY	SOT23-5L	High Level Active

All Chipown products are offered in Pb-free packaging. The term “Pb-free” means semiconductor products that are in compliance with current RoHS standards, including the requirement that lead not exceed 0.1% by weight in homogeneous materials. For more information, please contact our sales department

# AP1610

# Chipown

## Package Information SOT23-5L

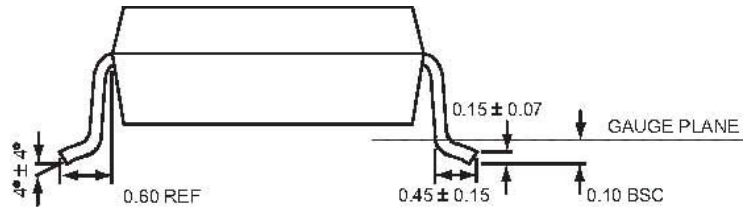
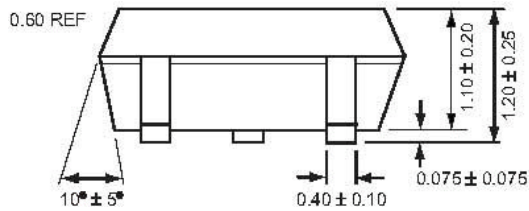
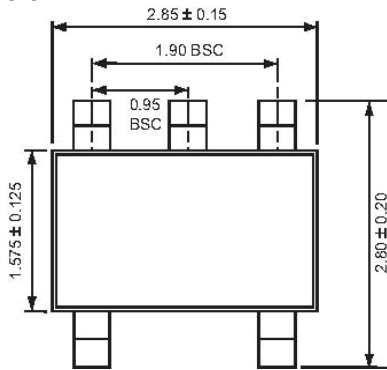

All dimensions in millimeters

## IMPORTANT NOTICE

Chipown Microelectronics Co. Ltd. reserves the right to make changes without further notice to any products or specifications herein. Chipown Microelectronics Co. Ltd. does not assume any responsibility for use of any its products for any particular purpose, nor does Chipown Microelectronics Co. Ltd assume any liability arising out of the application or use of any its products or circuits. Chipown Microelectronics Co. Ltd does not convey any license under its patent rights or other rights nor the rights of others